



ACURA

◆ WITH YOU ON SITE



Contents

WHO WE ARE	4
HOW WE CAN HELP	5
DELIVERY	6

STRUT & HANGING SUPPORTS **8 - 45**

Strut, cantilever brackets, strut nuts, angle brackets, flat plate fittings, base plates, u shape fittings, wing fittings, strut joiners, strut closures, Pressix channel, siFramo modular framing, angle, threaded rod, stiffener tube, mounting plates, beam clamps, hangers and clips, Zip-Clip, wire, rope, chain, gas riser supports, welded / rubber lined nutclips, pipe hangers, allthread clips, heavy duty clamps, downpipe brackets, fire service clamps, stand-off saddles and brackets, stainless steel clamps, clip heads, strut clips and accessories, refrigeration clips, pipe saddles, ferrules, polyblock, thermoloc.

PASSIVE FIRE **46 - 51**

Cast-in collars / shells / extension top, Combat collars, puddle flange assemblies, retrofit collars, gas collars, Unicollar, pipe fire wraps, fire wrap, fire damper packing, fire pillows / boxes, fire rated board / insulation wrap, fire sealants.

PLUMBING **52 - 77**

Sound lagging, Thermobreak lagging, solar lagging, Foilflex no-clad lagging, NBR insulation, drain lagging, plumbing consumables, pipe sealants / markers, copper press fittings, copper press XL fittings, copper tube, copper tube refrigeration R410a, weld fittings.

HVAC **78 - 87**

Pressure PVC fittings and pipe, hose clamps, spring hanger box kits, spring hanger kits, springs and accessories, neoprene and seismic mounts, isolation rubbers, waffle pads, duct hangers, duct strapping, j cleats, register springs.

ELECTRICAL **88 - 97**

StudBite, ECT / AT3 / AT5 cable tray and accessories, fire rated cable ladder / tray and accessories, perforated cable tray, cable mesh basket, con-lock fixings, Zip-Clip lock, catenary wire, wire rope, conduit, electrical consumables, clips and saddles.

FASTENERS & FIXINGS **98 - 125**

Vertigos, drop-in anchors, concrete screw anchors, concrete inserts, sleeve anchors, suspension anchors, through bolts, seismic rated through bolts, screw bolts, seismic rated concrete screw bolts, chemical anchors, masonry plugs, metal pin anchors, spikes, wall dogs, cavity fixings, plastic plugs, nylon anchors, gas fixings, pa fixings, plasterboard fixings, insulation fixings, cable ties, bolts, nuts, metal threads, headless screws, tie wires, washers, nails, drillpoint screws, type 17 screws, needlepoint screws, rivets.

CONSUMABLES & SAFETY **126 - 139**

Silicone, sealants, adhesives, backer rod, grout and concrete, tapes, solvents and cleaners, cutting lubricants, markers, permanent markers, paint, crayons, chalk, building products, string lines, welding, welding rods, batteries, hand protection, head protection, hearing protection, eye and face protection, respiratory protection, site safety, fire extinguishers.

TOOLS **140 - 173**

Threaded rod cutters, metal stud punch, pipe cutters, Zip-Clip tools, Velpress tools, drop-in setting tools, hollow wall anchor setting tool, chemical anchor tools, cobra gas tools, Milwaukee skins / tool kits / batteries / chargers, Novopress press tools, lasers, Exactcut saw kits, extension lead hooks, portable power and lights, SDS bits, diamond core drills, diamond core bits, HSS drill bits, screwdriver bits, spear bits, right angle drive, auger bits, spade bits, holesaws, cut off wheels, internal pipe cutter, grinding wheels, diamond blades, saw blades, flap discs, wire wheels, sandpaper, reciprocating blades, jigsaw blades, hacksaw blade, multi tool blade, knives and blades, caulking guns, soldering tools, duct tools, brooms, spanners and sockets, star picket tool, cable tie tensioners, platform ladders, storage equipment and solutions.

INDEX **174 - 180**

REFERENCE GUIDES **181 - 183**

Screw/bolt size identification, chemical usage chart, HVAC strut clip size chart, pipe reference guides, pressure conversions, pressure conversion rates (rounded), metric conversions, imperial fraction to metric conversions, flow conversions, power conversions, temperature conversions.

1300 750 750

www.acuragroup.com.au

sales@acuragroup.com.au

S.A. Office: 10 Selgar Avenue, Tonsley, S.A. 5042

W.A. Office: 19 Wicks Street, Bayswater, W.A. 6053



Who we are

ACURA Group

- ◆ A trusted supplier to the construction industry in South Australia, Western Australia and the Northern Territory, ACURA Group brings together quality, innovative products and tailored solutions. A family owned and operated business; our success has been built on sound technical knowledge and world-class service.

We will help you keep your commercial projects on time and on budget, with a massive range of Plumbing, Electrical, Passive Fire (fire services) and HVAC (heating, ventilation and air conditioning) products delivered directly to you on site. We understand that no two projects are the same, which is why we also provide custom solutions that will stand the test of time.

We don't just have the products, our product specialists combine with qualified engineers to create solutions together. We're not just your supplier; we're your partner!

We've built quite a portfolio over the years. You'll find our products and expertise in iconic Adelaide and Perth builds like the Osborne Naval Shipyard, Adelaide Oval, nRAH and SAHMRI, New Perth Stadium and Next DC Data Centre in Perth, as well as urban developments like the Bowden Precinct, and chain developments like Aldi.



How we can help

We're with you on site



When you're on site, 'perhaps' and 'maybe' just won't cut it. You need certainty and reliability. In fact, you demand it. That's why ACURA Group is the name more contractors trust. When it comes to meeting project deadlines, we deliver.

- We know our stuff – technical knowledge plus expert support to keep you compliant on site.
- You need it, we deliver it – we deliver directly to you on site when you need it.
- Stacks of stock – we have what you need, and we have plenty of it.
- Customer approved - satisfied customers are what we live for.

Specialist supplier

- Your specialist solutions supplier for the construction industry in SA and WA, covering Plumbing, HVAC, Electrical and Fire Services

Huge range in stock

- We stock what we sell. Our fill rate is more than 97% (Dec 2022), which means we can dispatch to site in lightning speed
- Over 7,000 items in stock
- We're the experts at sourcing hard to find products

Fast, friendly delivery

- Same day delivery to you on site
- Multiple delivery runs per day with on-demand VIP delivery service available
- Over 99% of delivery runs leave on time, with guaranteed delivery within 2 hours and Adelaide and 3 hours in Perth
- A complimentary box of biscuits with every delivery

Customer testimonials

- Our customers are our best endorsement
- Our regular Net Promoter Score surveys have a world-class customer satisfaction score of 80+





Fast Delivery

You want to work, not wait. That's why we deliver to you on site, and we deliver fast. We have a large range in stock at our Adelaide and Perth warehouses, always ready to dispatch straight to you when needed, on one of our five delivery runs a day in the Adelaide and Perth metropolitan areas. We can respond to your short notice orders too, with our VIP delivery service ready to run when you need it, meaning you are not bound to any delivery times. Additional charges may apply.



We aim to deliver within two hours of a delivery run leaving our warehouse.

Adelaide - SA

- 7:30am - cut off 7:00am
- 10:00am - cut off 9:30am
- 12:30pm - cut off 12:00pm
- 2:00pm - cut off 1:30pm
- 3:30pm - cut off 3:00pm

Perth - WA

- 7:00am - cut off 4:00pm previous day
- 9:30am - cut off 9:00am
- 12:30pm - cut off 12:00pm
- 2:00pm - cut off 1:30pm
- 3:30pm - cut off 3:00pm

Our speed of delivery is measured daily, with 99% of runs leaving on time.

Please note: large orders may require extra time.



Specialist Products



Custom Solutions



WITH YOU ON SITE



◆ Strut & Hanging Supports





CONTENTS	PAGE
STRUT	10
CANTILEVER BRACKETS	12
STRUT NUTS	12
ANGLE BRACKETS	13
FLAT PLATE FITTINGS	14
BASE PLATES	14
U SHAPE FITTINGS	15
WING FITTINGS	15
STRUT BEAM CLAMPS	15
STRUT JOINERS	15
STRUT CLOSURES	16
PRESSIX CHANNEL	16
SIFRAMO MODULAR FRAMING	18
ANGLE	22
THREADED ROD	23
STIFFENER TUBE	23
MOUNTING PLATES	24
BEAM CLAMPS	24
HANGERS & CLIPS	25
ZIP-CLIP	27
WIRE ROPE & ACCESSORIES	29
WIRE & CHAIN	29
GAS RISER SUPPORTS	30
WELDED NUTCLIPS	32
PIPE HANGERS	33
ADJUSTABLE ALLTHREAD CLIPS	33
RUBBER LINED NUTCLIPS	35
HEAVY DUTY CLAMPS	35
DOWNPIPE BRACKETS	35
FIRE SERVICE CLAMPS	36
STAND OFF SADDLES & BRACKETS	37
STAINLESS STEEL CLAMPS	37
CLIP HEADS	38
STRUT CLIPS & ACCESSORIES	39
REFRIGERATION CLIPS	41
PIPE SADDLES	42
FERRULES	43
POLYBLOCK	45
THERMOLOC	45



SLOTTED STRUT

SLOTTED STRUT 40X40



PART N°	QF	LENGTH (mm)	FINISH	MATERIAL SIZE (mm)	QTY
19D1000T	A0727	6000	GAL	40 x 40 x 2.5	25
19D1000T-3	A0728	3000	GAL	40 x 40 x 2.5	25

SLOTTED STRUT 40X40 HOT-DIP GALVANISED



PART N°	QF	LENGTH (mm)	FINISH	MATERIAL SIZE (mm)	QTY
19D1000THDG	A0730	6000	HDG	40 x 40 x 2.5	25

SLOTTED STRUT 40X40 STAINLESS STEEL



PART N°	QF	LENGTH (mm)	FINISH	MATERIAL SIZE (mm)	QTY
19D1000TSS	A0731	6000	SS316	40 x 40 x 2.5	25

SLOTTED STRUT 40X40 LIGHT GAUGE



PART N°	QF	LENGTH (mm)	FINISH	MATERIAL SIZE (mm)	QTY
19D2000T	A0768	6000	GAL	40 x 40 x 1.6	25

SLOTTED STRUT 40X20



PART N°	QF	LENGTH (mm)	FINISH	MATERIAL SIZE (mm)	QTY
19D3300T	A0793	6000	GAL	40 x 20 x 2.5	25
19D3300T-3	A0794	3000	GAL	40 x 20 x 2.5	25

SLOTTED STRUT 40X20 HOT-DIP GALVANISED



PART N°	QF	LENGTH (mm)	FINISH	MATERIAL SIZE (mm)	QTY
19D3300THDG	A0795	6000	HDG	40 x 20 x 2.5	25

SLOTTED STRUT 40X20 LIGHT GAUGE



PART N°	QF	LENGTH (mm)	FINISH	MATERIAL SIZE (mm)	QTY
19D4400T	A0797	6000	GAL	40 x 20 x 1.6	25

SLOTTED STRUT 40X60



PART N°	QF	LENGTH (mm)	FINISH	MATERIAL SIZE (mm)	QTY
19D5500T	A0809	6000	GAL	40 x 60 x 2.5	20



SOLID STRUT

SOLID STRUT 40X40



PART N°	QF	LENGTH (mm)	FINISH	MATERIAL SIZE (mm)	QTY
19D1000	A0723	6000	GAL	40 x 40 x 2.5	25

SOLID STRUT 40X40 STAINLESS STEEL



PART N°	QF	LENGTH (mm)	FINISH	MATERIAL SIZE (mm)	QTY
19D1000SS	A0726	6000	SS316	40 x 40 x 2.5	25

SOLID STRUT 40X20



PART N°	QF	LENGTH (mm)	FINISH	MATERIAL SIZE (mm)	QTY
19D3300	A0789	6000	GAL	40 x 20 x 2.5	25

SOLID STRUT 40X20 LIGHT GAUGE



PART N°	QF	LENGTH (mm)	FINISH	MATERIAL SIZE (mm)	QTY
19D4400	A0796	6000	GAL	40 x 20 x 1.6	25

SOLID STRUT 40X40 HOT-DIP GALVANISED



PART N°	QF	LENGTH (mm)	FINISH	MATERIAL SIZE (mm)	QTY
19D1000HDG	A0725	6000	HDG	40 x 40 x 2.5	25

SOLID STRUT 40X40 LIGHT GAUGE



PART N°	QF	LENGTH (mm)	FINISH	MATERIAL SIZE (mm)	QTY
19D2000	A0767	6000	GAL	40 x 40 x 1.6	25

SOLID STRUT 40X20 HOT-DIP GALVANISED



PART N°	QF	LENGTH (mm)	FINISH	MATERIAL SIZE (mm)	QTY
19D3300HDG	A0792	6000	HDG	40 x 20 x 2.5	25

SOLID STRUT 40X60



PART N°	QF	LENGTH (mm)	FINISH	MATERIAL SIZE (mm)	QTY
19D5500	A0808	6000	GAL	40 x 60 x 2.5	20

BACK TO BACK STRUT



PART N°	QF	LENGTH (mm)	FINISH	MATERIAL SIZE (mm)	QTY
19D1001HDG	A0732	6000	HDG	40 x 80 x 2.5	10



CANTILEVER BRACKETS

BRACED CANTILEVER BRACKET



PART N°	QF	LENGTH (mm)	FINISH	QTY
19ECB300	A0818	300	HDG	1
19ECB450	A0819	450	HDG	1
19ECB600	A0820	600	HDG	1
19ECB750	A0821	750	HDG	1
19ECB900	A0822	900	HDG	1

UNBRACED CANTILEVER BRACKET



PART N°	QF	LENGTH (mm)	FINISH	QTY
19KH150	A0837	150	HDG	1
19KH300	A0838	300	HDG	1
19KH450	A0839	450	HDG	1
19KH600	A0840	600	HDG	1
19KH700	A0841	700	HDG	1

STRUT NUTS

STRUT NUT - LONG SPRING



PART N°	QF	FINISH	THREAD SIZE	QTY
19UA506	A0733	ZINC	M6	100
19UA608	A0735	ZINC	M8	100
19UA810	A0737	ZINC	M10	200
19UA812	A0740	ZINC	M12	100
19UA816	A0742	ZINC	M16	50
19UA608G	A0736	HDG	M8	100
19UA810G	A0738	HDG	M10	200
19UA812G	A0741	HDG	M12	100
19UA816G	A0743	HDG	M16	100

SQUARE BASE UNBRACED CANTILEVER BRACKET



PART N°	LENGTH (mm)	FINISH	QTY
19SCB800	800	HDG	1
19SCB1000	1000	HDG	1
19SCB1500	1500	HDG	1
19SCB2000	2000	HDG	1

STRUT NUT - SHORT SPRING



AVAILABLE IN HDG

PART N°	QF	FINISH	THREAD SIZE	QTY
19UD506	A0798	ZINC	M6	100
19UD608	A0800	ZINC	M8	100
19UD810	A0802	ZINC	M10	100
19UD812	A0804	ZINC	M12	100

STRUT NUT - NO SPRING



AVAILABLE IN HDG

PART N°	QF	FINISH	THREAD SIZE	QTY
19UM506	A0780	ZINC	M6	100
19UM608	A0782	ZINC	M8	100
19UM810	A0784	ZINC	M10	100
19UM812	A0786	ZINC	M12	100

SPEEDNUT STRUT NUT



PART N°	QF	FINISH	THREAD SIZE	QTY
42180218	A0909	ZINC	M10	50

BUTTERFLY NUT



PART N°	QF	FINISH	THREAD SIZE	QTY
19BN06	A0716	ZINC	M6	100

SN SERIES NUT



PART N°	QF	FINISH	THREAD SIZE	QTY
1939007	A0714	ZINC	M10	100
1939008	-	ZINC	M12	100

T-NUT



PART N°	QF	THREAD SIZE	QTY
19T10	A0863	M10	50
19T12	-	M12	50



ANGLE BRACKETS

ANGLE BRACKET - 2 HOLE

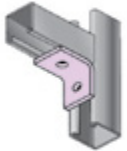

PART N°	QF	SIZE (mm)	FINISH	QTY
19ZWA200	A0744	48 x 51	HDG	50
15ZWA2182	A0319	65 x 65	HDG	25

ANGLE BRACKET - 3 HOLE

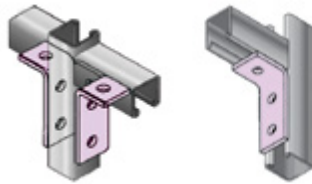

PART N°	QF	SIZE (mm)	FINISH	QTY
19ZWA203	A0759	41 x 105	HDG	30

ANGLE BRACKET - 4 HOLE

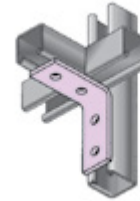

PART N°	QF	SIZE (mm)	FINISH	QTY
19ZWA205	A0758	89 x 105	HDG	20

ANGLE BRACKET - 4 HOLE BRACED

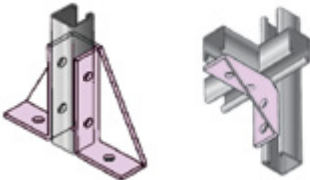

PART N°	QF	SIZE (mm)	FINISH	QTY
19ZWA207	A0776	102 x 102	HDG	50

INTERNAL ANGLE BRACKET - 45°



PART N°	QF	FINISH	QTY
19D1186	A0753	HDG	80

EXTERNAL ANGLE BRACKET - 45°

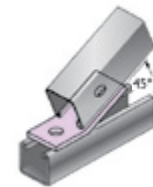

PART N°	QF	FINISH	QTY
19D1546	A0765	HDG	100

WIDE ANGLE TEE BRACKET



PART N°	QF	SIZE (mm)	FINISH	QTY
19ZWA209	A0761	90 x 105	HDG	50

ANGLE BRACE - 45 DEGREE



PART N°	QF	LENGTH	FINISH	QTY
19D2452	A0775	422	HDG	20



FLAT PLATE FITTINGS

FLAT PLATE - 1 HOLE

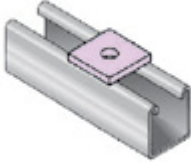
					
PART N°	QF	SIZE (mm)	TO SUIT	FINISH	QTY
19ZEA100	A0748	40 x 40 x 6	M10	HDG	100
19ZEA10012	A0749	40 x 40 x 6	M12	HDG	100

FLAT PLATE RIGHT ANGLE

				
PART N°	QF	SIZE (mm)	FINISH	QTY
19ZEA107	A0746	90 x 90	HDG	40

FLAT PLATE - 2 HOLE

				
PART N°	QF	SIZE (mm)	FINISH	QTY
19ZEA102	A0750	92	HDG	60

BASE PLATES

HEAVY DUTY STRUT BASE PLATE

					
PART N°	QF	SIZE (mm)	TO SUIT	FINISH	QTY
19P11000HD-45	A0770	150 x 150 x 89	19D1000	HDG	10
19P11000HD	-	150 x 150 x 89	19D1000	HDG	10

FLAT PLATE TEE

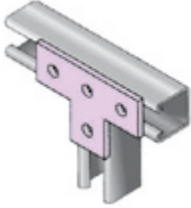
				
PART N°	QF	SIZE (mm)	FINISH	QTY
19ZEA108	A0745	90 x 138	HDG	80

FLAT PLATE - 4 HOLE

				
PART N°	QF	SIZE (mm)	FINISH	QTY
19ZEA104	A0751	186	HDG	20

SQUARE WASHER

				
PART N°	QF	TO SUIT	MATERIAL SIZE (mm)	QTY
19SQW10	A0858	M10	40 x 40 x 3	100
19SQW125050G	A0859	M12	50 x 50 x 5	100
19SQW12G	-	M12	40 x 40 x 3 HDG	100
19SQW16	A0861	M16	50 x 50 x 5	100
19SQW20	A0862	M20	65 x 65 x 5	50

STRUT BASE PLATE

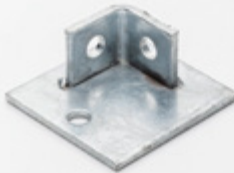
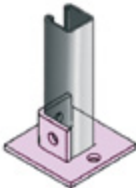
					
PART N°	QF	SIZE (mm)	TO SUIT	FINISH	QTY
19ZGA501	A0769	100 x 100 x 40	19D1000	HDG	20

BACK TO BACK STRUT BASE PLATE

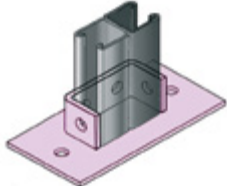
					
PART N°	QF	SIZE (mm)	TO SUIT	FINISH	QTY
19P13000HD	A0771	150 x 150 x 40	19D1001	HDG	8



U SHAPE FITTINGS

U SHAPE BRACKET - 40X20

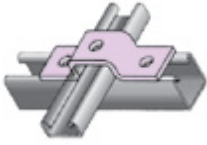
				
PART N°	QF	SIZE (mm)	FINISH	QTY
19ZUA401	A0806	40 x 20 x 137	HDG	75

U SHAPE BRACKET - 40X40 / 40X62

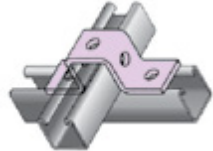
				
PART N°	QF	SIZE (mm)	FINISH	QTY
19ZUA400	A0747	40 x 40 x 137	HDG	40
19ZUA601	-	40 x 62 x 137	HDG	30

WING FITTINGS

CORNER WING FITTING

		
PART N°	FINISH	QTY
19Z2224	HDG	1

3-WAY WING FITTING

		
PART N°	FINISH	QTY
19Z2228	HDG	1

2-WAY WING FITTING

		
PART N°	FINISH	QTY
19ZZA702	HDG	1

STRUT BEAM CLAMPS

ADJUSTABLE BEAM CLAMP

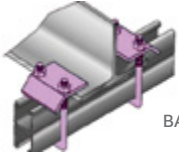
		BACK TO BACK STRUT PICTURED		
PART N°	QF	SUITS	FINISH	QTY
19ZTA601	A0778	40 x 40 STRUT	HDG	30
19ZTA601-L	-	40 x 80 STRUT	HDG	30

WINDOW BRACKET BEAM CLAMP

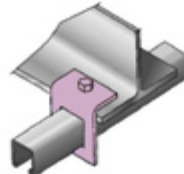
				
PART N°	QF	SIZE (mm)	FINISH	QTY
19ZZ704	A0766	45 x 89	HDG	30

LOCKING BEAM CLAMP

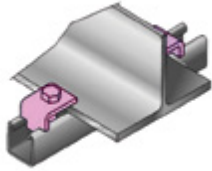
				
PART N°	QF	SIZE (mm)	FINISH	QTY
19ZTA605	A0763	40 x 55	HDG	50

INTERNAL BEAM CLAMP SET

			
PART N°	QF	FINISH	QTY
19D3087	A0788	HDG	100

STRUT JOINERS

STRUT JOINER - EXTERNAL

			
PART N°	QF	FINISH	QTY
19ZEA1377LD	A0773	GAL	40

STRUT JOINER - INTERNAL

			
PART N°	QF	FINISH	QTY
19ZEA922J	A0811	GAL	40

STRUT JOINER TEE

			
PART N°	QF	FINISH	QTY
19ZEA1221	A0755	GAL	15



STRUT CLOSURES

STRUT COVER

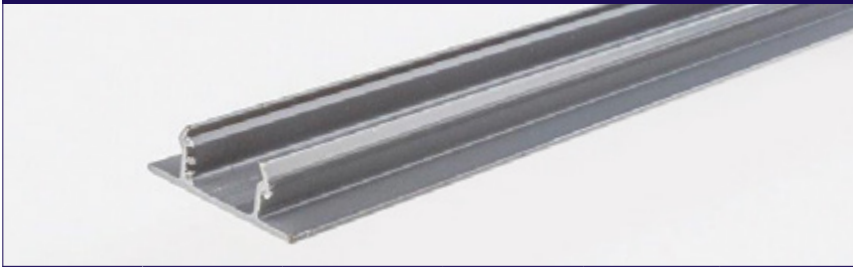

PART N°	QF	LENGTH (mm)	SIZE (mm)	TO SUIIT	QTY
19COV403	A0721	3000	41	ALL STRUT	100

STRUT END CAPS



PART N°	QF	SIZE (mm)	TO SUIIT	QTY
19ENDC21	A0823	41 x 21	D3300	100
19ENDC41	A0824	41 x 41	D1000	100

PRESSIX CHANNEL

PRESSIX 27X27 CHANNEL



PART N°	QF	LENGTH (mm)	SIZE (mm)	FINISH	QTY
42198025	A0713	3000	27 x 27	GALVABOND	150





siFramo Modular Steelwork Solutions

siFramo is a multi-functional, non-welded support system for the modular construction of framing solutions.

This amazing product simply screws together, eliminating the need of drilling, bolting and welding, effectively preventing on-site delays through its pregalvanised finish.

Features

- Non-welded modular steelwork
- Higher performance / lower weight of steel
- Maximum flexibility, minimum installation time
- Easy to assemble and disassemble
- Compatible with other installation systems
- High corrosion resistance as standard
- One thread forming screw for all component connections
- Frame and module assembly modifications can be made quickly on site with no loss of time, cut-outs or re-works

siFramo has revolutionised support structures for services by providing the first real alternative to welding structural framework for supporting weights beyond capacity of strut.

Parts are reusable

Multiple applications

*Conditions apply.

*Free design service.

Seismic rating available to make sure your project is **compliant**.





SIFRAMO

SIFRAMO BEAM SECTION



PART N°	QF	LENGTH (mm)	SIZE (mm)	QTY
42192539	A0936	6000	80 x 80	20
42112904	A0871	6000	100 x 100	12

SIFRAMO BASE PLATE



PART N°	QF	SIZE (mm)	QTY
42192801	A0943	220 x 220 x 192	1
42113075	A0873	220 x 220 x 232	1

SIFRAMO OCTAGONAL COUPLING



PART N°	QF	SIZE (mm)	QTY
	A0869	73 x 280	1

SIFRAMO END SUPPORT - 4 HOLE



PART N°	QF	SIZE (mm)	QTY
42192856	A0948	190 x 80 x 148	1
42113073	A0872	210 x 100 x 188	1

SIFRAMO END SUPPORT - 4 HOLE OFFSET



PART N°	QF	SIZE (mm)	QTY
42192863	A0949	190 x 80 x 148	1

SIFRAMO PIVOT JOINT



PART N°	QF	SIZE (mm)	QTY
42113835	A0875	80 x 80 x 140	1
42113838	A0876	100 x 100 x 140	1

SIFRAMO BEAM SECTION TORSIONAL STIFFNESS COMPARISON

Comparison with torsional moment of inertia I_z (cm⁴)

The torsional stiffness of siFramo 80 is approximately 2 to 3 orders of magnitude greater than with open profiles.

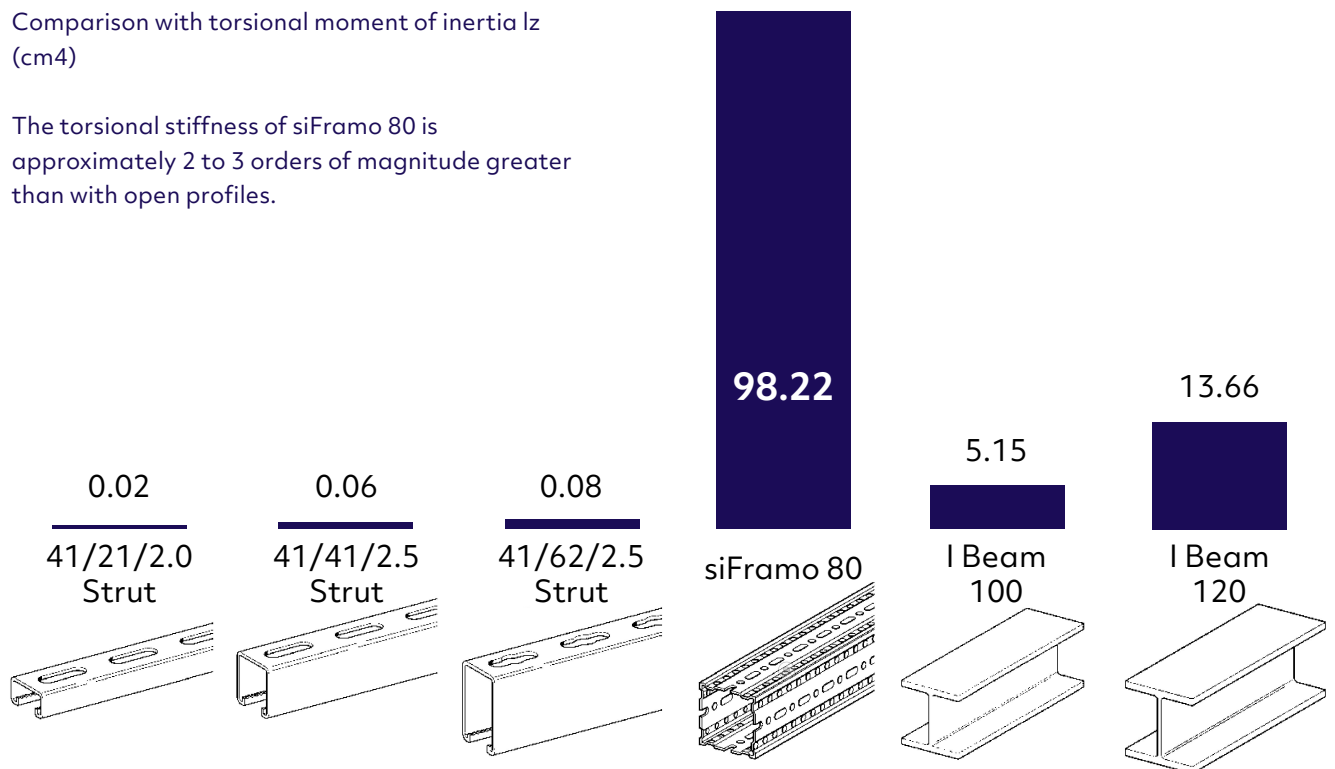



SIFRAMO STRUT ADAPTER



PART N°	QF	SIZE (mm)	QTY
42192887	A0951	190 x 80	1

SIFRAMO BEAM SECTION HOLDER



PART N°	QF	SIZE (mm)	QTY
42111732	A0870	199 x 80	1

SIFRAMO SELF FORMING SCREW



PART N°	QF	SIZE (mm)	QTY
42192512	A0935	TX50 / 17mm	100

SIFRAMO TORX BIT

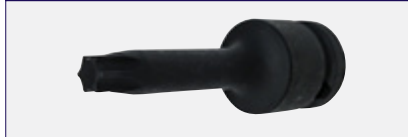

PART N°	QF	SIZE	QTY
25TX5012	-	T-50 x1/2 Drive	1

SIFRAMO U-HOLDER



PART N°	SIZE (mm)	TO SUIT FLANGE	QTY
42192683	80 x 80 x M10	Up to 16mm	1

SIFRAMO U-HOLDER - HEAVY DUTY



PART N°	SIZE (mm)	TO SUIT FLANGE	QTY
42194010	80 x 80 x M12	Up to 40mm	1

SIFRAMO END CAP



PART N°	QF	SIZE (mm)	QTY
42192674	A0937	80 x 80	25
42113086	A0874	100 x 100	25

THE PERFECT SYSTEM FOR TIME-SAVING SCREW CONNECTION

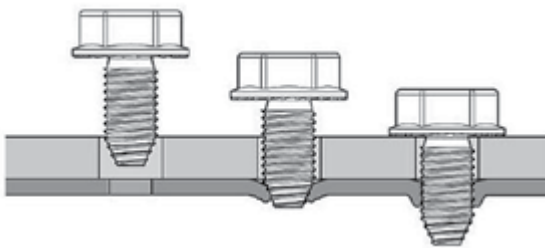

The siFramo system is assembled via thread-forming tapping screws.

The chip-less, custom-fitted cold-work hardening of the female thread means the screw develops form closure and no longer becomes loose.

They can also be removed and reused again - excellent for adjustments.

HCP COATING - HIGH CORROSION PROTECTION



All siFramo products come with the high-quality HCP coating as standard.

To meet the most stringent corrosion protection standards, siFramo support system is developed with a new individual multi-layer coating, a design which is confirmed as complying with the corrosion category C5-I. This is the highest corrosive category; hence the coating is suitable for industrial fields, involving exposure to high humidity and aggressive environmental conditions.



SIFRAMO PRE-FABRICATED SOLUTIONS

We support you in the planning and tendering process, provide logistics and, if you wish, produce to your specifications. Acura can provide professional assistance with application specialists and technical consultants, that will help tailor a solution for your project.



Acura can work with you, creating CAD drawings, detailing parts lists and schematics drawings, static calculations, and much more, developing a custom tailored solution designed to help you save time and costs.



Pre-assembled assembly units encompass the potential for great savings and are a key part of modern installations. We also produce customer tailored mounting solutions made of siFramo and deliver siFramo sections cut to length based on customer specification. This minimizes the installation work required, accelerates construction and allows certainty for calculation.

We can also assist you on-site with our know-how and a team of specialists, and help ensure assembly goes without a hitch.





Fischer UltraCut FBS II™

The Fischer concrete screw UltraCut FBS II is made of zinc-plated steel with an internal thread. It is perfectly designed for applications like fixings of pipe routes, channel systems, ventilation ducts and facilities in the building service engineering.



Fischer UltraCut FBS II
seismic anchor rod hanger

Fast and reliable solution

When the concrete screw is screwed into the drill hole using an impact driver, the thread flanks cut deep into the concrete, thus ensuring top load-bearing capacity. The low drilling effort saves time in the case of multiple fixations. The European Technical Approval for cracked concrete and non-cracked concrete as well as for seismic loads and classification into fire resistance class R120 guarantee even more safety.



Fire Rated
R120 (refer to ETA-15/0352 and ETA-18/0242 for load capacities under fire)



ETA-15/0352
Cracked & uncracked concrete
ETA-18/0242
Redundant non-structural applications

Features

- Approved for multiple use of non-load bearing systems and thereby ideal for the installation of pipe routes, cable trays and prestressed hollow concrete ceilings
- The design of the concrete screw with step thread offers maximum flexibility when mounting threaded rods or connecting elements
- Only requires 40mm embedment (seismic approved)
- ETA approved for cracked and uncracked concrete
- ETA approved for seismic loading
- ETA approved for redundant non-structural applications (6mm)
- R120 fire rated



Seismic C1
C1 on sizes with ETA approval

Independently tested and approved for use on solid uncracked / cracked concrete, and hollow core concrete.



See page 102 for more concrete screw anchors.



ANGLE

SLOTTED ANGLE



PART N°	QF	LENGTH (mm)	FINISH	MATERIAL SIZE (mm)	QTY
14GA3030SL	A0226	3000	ZINC	30 x 30 x 2.5	100
14GA4040SL	A0228	3000	ZINC	40 x 40 x 2.5	50
14GA5050SL3	A0234	3000	ZINC	50 x 50 x 5	30
14GA5050SL6	A0235	6000	ZINC	50 x 50 x 5	30
14GA6565SL6	A0239	6000	ZINC	65 x 65 x 5	10

SOLID ANGLE



PART N°	LENGTH (mm)	FINISH	MATERIAL SIZE (mm)	QTY
14GA3325	6000	GALV	30 x 30 x 2.5	100
14GA4425	6000	GALV	40 x 40 x 2.5	50
14GA4440	6000	GALV	40 X 40 X 4.0	50
14GA5525	6000	GALV	50 x 50 x 2.5	50
14GA5550	6000	GALV	50 x 50 x 5.0	50

SOLID ANGLE - REGISTER



PART N°	LENGTH (mm)	FINISH	MATERIAL SIZE (mm)	QTY
14GA33075P	2400	ZINC	30 x 30 x 0.75	1
14GA55075P	2400	ZINC	50 x 50 x 0.75	1
14GA5512P	2400	ZINC	50 x 50 x 1.2	1



THREADED ROD

ALLTHREAD - ZINC



PART N°	QF	LENGTH (mm)	FINISH	THREAD SIZE	QTY
13TRM61	-	1000	ZINC	M6	20
13TRM63	A0197	3000	ZINC	M6	20
13TRM81	-	1000	ZINC	M8	20
13TRM83	A0199	3000	ZINC	M8	20
13TRM103	A0204	3000	ZINC	M10	10
13TRM123	A0210	3000	ZINC	M12	10
13TRM163	A0215	3000	ZINC	M16	5
13TRM203	A0219	3000	ZINC	M20	2
13TRM303	-	3000	ZINC	M30	2

ALLTHREAD STUBS - ZINC

A0205	13TRM1035STUB	35	ZINC	M10	100
A0202	13TRM10100	100	ZINC	M10	100
A0203	13TRM10150	150	ZINC	M10	100

ALLTHREAD - GALVANISED



PART N°	QF	LENGTH (mm)	FINISH	THREAD SIZE	QTY
13TRM83G	-	3000	GAL	M8	20
13TRM103G	A0206	3000	GAL	M10	10
13TRM123G	A0211	3000	GAL	M12	10
13TRM163G	A0216	3000	GAL	M16	5
13TRM203G	A0220	3000	GAL	M20	5
13TRM241G	-	1000	GAL	M24	5
13TRM243G	A0222	3000	GAL	M24	5

ALLTHREAD - STAINLESS STEEL



PART N°	QF	LENGTH (mm)	FINISH	THREAD SIZE	QTY
13TRM63SS316	A0198	3000	SS316	M6	20
13TRM83SS316	A0200	3000	SS316	M8	10
13TRM103SS316	A0208	3000	SS316	M10	10
13TRM123SS316	A0213	3000	SS316	M12	5
13TRM163SS316	A0217	3000	SS316	M16	1

STIFFENER TUBE

THREADED ROD SLEEVING TUBE



PART N°	LENGTH (meter)	TO SUIT	QTY
15NBTUBE	6.5	15NB	1
20NBTUBE	6.5	20NB	1

For nuts and washers, please see page 118 - 120.



For concrete anchors, please see page 102.



For metal cut off wheels, please see page 162.





MOUNTING PLATES

VERTICAL MOUNTING PLATE



PART N°	QF	THREAD SIZE	QTY
15VMP10	A0316	M10	50
15VMP12	A0317	M12	100
15VMP10NP	-	M10	100

CENTRE MOUNTING PLATE



PART N°	QF	FINISH	THREAD SIZE	QTY
15CMP10	A0275	ZP	M10	50
15CMP12	A0278	ZP	M12	50
15CMP10SS	A0277	SS	M10	50

CENTRE MNTG. PLATE MALE THREAD



PART N°	QF	THREAD SIZE	QTY
15MMP10	ZINC	M10	50
15MMP10SS	SS	M10	50

HORIZONTAL MOUNTING PLATE



PART N°	FINISH	THREAD SIZE	QTY
15HMP10	A0288	M10	50
15HMP12	A0290	M12	100

BEAM CLAMPS

BEAM CLAMP LIGHT DUTY



PART N°	TO SUIT	HOLE SIZE (mm)	QTY
15DBC	M10	11	100

BEAM CLAMP



PART N°	TO SUIT	HOLE SIZE (mm)	QTY
15TK10	M10	11	50
15TK12	M12	13	100

BEAM CLAMP WIDE MOUTH



PART N°	TO SUIT	HOLE SIZE (mm)	QTY
15TK10WM	M10	11	50
15TK12WM	M12	13	100

THREADED BEAM CLAMP



PART N°	THREAD SIZE	QTY
42116150	M10/M10	50

ROD LOCK BEAM CLAMP



PART N°	TO SUIT	QTY
15CRLBM10	M10	100

EXTERNAL STRUT BEAM CLAMP



PART N°	TO SUIT	QTY
19D1271	40MM STRUT	1

INTERNAL STRUT BEAM CLAMP



PART N°	TO SUIT	QTY
19ZT606	20/40MM STRUT	1



HANGERS AND CLIPS

PURLIN HANGER



PART N°	QF	THREAD SIZE	QTY
15DPH10	A0286	M10	50
15DPH12	A0287	M12	100

D PURLIN HANGER



PART N°	QF	TO SUIT	HOLE SIZE (mm)	QTY
15D1-M10	A0280	M10	11	50
15D1-M12	A0281	M12	13	50

PURLIN HANGER - LIGHT DUTY



PART N°	QF	THREAD SIZE	QTY
15VF14M10TI	A0313	M10	100

PURLIN CLIP



PART N°	QF	SIZE (mm)	QTY
15DPC	A0284	1.6-2.5	100

PURLIN CLEAT - M10



PART N°	QF	TO SUIT	QTY
15PC2300	A0304	M10	100

PURLIN CLEAT - M12



PART N°	QF	TO SUIT	QTY
15PC2200	A0303	M12	100

GIRDER CLAMP



PART N°	QF	SIZE (mm)	TO SUIT	QTY
152H4	A0256	2-3	50PVC	100
154H24	A0260	3-7	100PVC	100
154H58	A0261	8-13	150PVC	100
154H912	A0262	14-20	-	100

THREADED GIRDER CLAMP



PART N°	QF	SIZE (mm)	TO SUIT	QTY
15M10TI24	A0292	3-7	M10	100
15M10TI58	A0294	8-13	M10	100
15M10TI912	A0295	15-20	M10	100

THREADED SUPPORT



PART N°	QF	TO SUIT	QTY
15M6TI	A0296	M6	100
15M8TI	A0297	M8	100
15M10TI	A0291	M10	100

U-BOLT CLEAT



PART N°	QF	TO SUIT	QTY
15PC1900	A0300	M6	200
15PC2000	A0301	M10	100
15PC2001	A0302	M12	100

CLEVIS HANGER



PART N°	QF	TO SUIT	FINISH	QTY
16ERIC10	A0338	M10	HDG	50
16ERIC12	A0339	M12	HDG	50
16ERIC16	A0340	M16	HDG	50

LIGHT DUTY ANGLE BRACKET



PART N°	QF	SIZE (mm)	QTY
16AC3020	A0264	25 x 25 x 16 x 1.6	100

THREADED ROD CLAMP STUD



PART N°	QF	THREAD SIZE	QTY
15RCS10	A0305	M10	100

UNIVERSAL JOINT



PART N°	QF	THREAD SIZE	QTY
42198643	A0973	M10	1

SUSPENSION ROD BRACKET - 3 HOLE



PART N°	SIZE (mm)	QTY
462H1	25 x 80	1



SUPERIOR HANGING TECHNOLOGY

Zip-Clip

Zip-Clip is a range of innovative products designed for speed and ease of use. The clip is manufactured from a high quality zinc alloy. The oil impregnated sintered metal wedge is designed to offer the best locking solution.

The stainless steel spring ensures the wedge engages first time. The galvanised high tensile wire rope supplied offers you a better SWL than those found on the market. All our engineered suspension products are designed with quality and safety in mind.





ZIP-CLIP KITS - 2MM

2MM LOOP END



ZIP-CLIP KIT 2MM LOOP END AND ZIP-CLIP					
PART N°	QF	LENGTH (mm)	SIZE (mm)	WORKING LOAD (kg)	QTY
17HF02-1M-L	A0582	1000	2	50	10
17HF02-2M-L	A0597	2000	2	50	10
17HF02-3M-L	A0615	3000	2	50	10
17HF02-4M-L	A0631	4000	2	50	10
17HF02-6M-L	A0639	6000	2	50	10
ZIP-CLIP KIT 2MM LOOP END AND DUCT HANGER					
PART N°	QF	LENGTH (mm)	SIZE (mm)	WORKING LOAD (kg)	QTY
17HF02-1M-DT	A0584	1000	2	50	10
17HF02-2M-DT	A0599	2000	2	50	10
17HF02-3M-DT	A0617	3000	2	50	10
ZIP-CLIP KIT 2MM LOOP END AND STRUT LOCK TRAPEZE					
PART N°	QF	LENGTH (mm)	SIZE (mm)	WORKING LOAD (kg)	QTY
17HF02-1M-SL	A1086	1000	2	50	10
17HF02-2M-SL	A1087	2000	2	50	10
17HF02-3M-SL	A0618	3000	2	50	10

2MM PURLIN CLIP END



ZIP-CLIP KIT 2MM PURLIN CLIP END AND ZIP-CLIP					
PART N°	QF	LENGTH (mm)	SIZE (mm)	WORKING LOAD (kg)	QTY
17HF02-1M-PC	A0585	1000	2	50	10
17HF02-2M-PC	A0600	2000	2	50	10
17HF02-3M-PC	A0619	3000	2	50	10
17HF02-4M-PC	A0633	4000	2	50	10
17HF02-6M-PC	A0641	6000	2	50	10
ZIP-CLIP KIT 2MM PURLIN CLIP END AND DUCT HANGER					
PART N°	QF	LENGTH (mm)	SIZE (mm)	WORKING LOAD (kg)	QTY
17HF02-1M-PCDT	A0587	1000	2	50	10
17HF02-2M-PCDT	A0602	2000	2	50	10
17HF02-3M-PCDT	A0621	3000	2	50	10
ZIP-CLIP KIT 2MM PURLIN CLIP END AND STRUT LOCK TRAPEZE					
PART N°	QF	LENGTH (mm)	SIZE (mm)	WORKING LOAD (kg)	QTY
17HF02-1M-PCSL	A1088	1000	2	50	10
17HF02-2M-PCSL	A1089	2000	2	50	10
17HF02-3M-PCSL	A0622	3000	2	50	10

2MM CON-LOCK END



ZIP-CLIP KIT 2MM CON-LOCK END AND ZIP-CLIP					
PART N°	QF	LENGTH (mm)	SIZE (mm)	WORKING LOAD (kg)	QTY
17HF02-1M-FNA	A0593	1000	2	50	10
17HF02-2M-FNA	A0611	2000	2	50	50
17HF02-3M-FNA	A0627	3000	2	50	50
17HF02-4M-FNA	A0636	4000	2	50	50
17HF02-6M-FNA	A0643	6000	2	50	50
ZIP-CLIP KIT 2MM CON-LOCK END AND DUCT HANGER					
PART N°	QF	LENGTH (mm)	SIZE (mm)	WORKING LOAD (kg)	QTY
17HF02-1M-WDT	A0595	1000	2	50	10
17HF02-2M-WDT	A0613	2000	2	50	10
17HF02-3M-WDT	A0629	3000	2	50	10
ZIP-CLIP KIT 2MM CON-LOCK END AND STRUT LOCK TRAPEZE					
PART N°	QF	LENGTH (mm)	SIZE (mm)	WORKING LOAD (kg)	QTY
17HF02-1M-WSL	A1090	1000	2	50	10
17HF02-2M-WSL	A1091	2000	2	50	10
17HF02-3M-WSL	A1092	3000	2	50	10

* Refer page page 142 for Zip-Clip Tools.



2MM SHOT FIRE END



ZIP-CLIP KITS - 3MM

3MM LOOP END



3MM PURLIN CLIP END



3MM CON-LOCK END



* Refer page page 142 for Zip-Clip Tools.

ZIP-CLIP KIT 2MM SHOT FIRE END AND ZIP-CLIP

PART N°	QF	LENGTH (mm)	SIZE (mm)	WORKING LOAD (kg)	QTY
17HF02-1M-S	A0588	1000	2	50	10
17HF02-2M-S	A0603	2000	2	50	10
17HF02-3M-S	0623	3000	2	50	10

ZIP-CLIP KIT 2MM SHOT FIRE END AND DUCT HANGER

PART N°	QF	LENGTH (mm)	SIZE (mm)	WORKING LOAD (kg)	QTY
17HF02-1M-SDT	A1093	1000	2	50	10
17HF02-2M-SDT	A1094	2000	2	50	10
17HF02-3M-SDT	A1095	3000	2	50	10

ZIP-CLIP KIT 2MM SHOT FIRE END AND STRUT LOCK TRAPEZE

PART N°	QF	LENGTH (mm)	SIZE (mm)	WORKING LOAD (kg)	QTY
17HF02-1M-SSL	A1096	1000	2	50	10
17HF02-2M-SSL	A1097	2000	2	50	10
17HF02-3M-SSL	A1098	3000	2	50	10

ZIP-CLIP KIT 3MM LOOP END AND ZIP-CLIP

PART N°	QF	LENGTH (mm)	SIZE (mm)	WORKING LOAD (kg)	QTY
17HF03-1M-L	A0647	1000	3	120	10
17HF03-2M-L	A0653	2000	3	120	10
17HF03-3M-L	A0659	3000	3	120	10

ZIP-CLIP KIT 3MM LOOP END AND TRAPEZE

PART N°	QF	LENGTH (mm)	SIZE (mm)	WORKING LOAD (kg)	QTY
17HF03-1M-LTZ	A1099	1000	3	120	10
17HF03-2M-LTZ	A1100	2000	3	120	10
17HF03-3M-LTZ	A1101	3000	3	120	10

ZIP-CLIP KIT 3MM PURLIN CLIP END AND ZIP-CLIP

PART N°	QF	LENGTH (mm)	SIZE (mm)	WORKING LOAD (kg)	QTY
17HF03-1M-PC	A0649	1000	3	120	10
17HF03-2M-PC	A0655	2000	3	120	10
17HF03-3M-PC	A0661	3000	3	120	10

ZIP-CLIP KIT 3MM PURLIN CLIP END AND TRAPEZE

PART N°	QF	LENGTH (mm)	SIZE (mm)	WORKING LOAD (kg)	QTY
17HF03-1M-PCTZ	A1102	1000	3	120	10
17HF03-2M-PCTZ	A1103	2000	3	120	10
17HF03-3M-PCTZ	A1104	3000	3	120	10

ZIP-CLIP KIT 3MM CON-LOCK END AND ZIP-CLIP

PART N°	QF	LENGTH (mm)	SIZE (mm)	WORKING LOAD (kg)	QTY
17HF03-1M-FNA	A0650	1000	3	120	10
17HF03-2M-FNA	A0657	2000	3	120	10
17HF03-3M-FNA	A0662	3000	3	120	10

ZIP-CLIP KIT 3MM CON-LOCK END AND TRAPEZE

PART N°	QF	LENGTH (mm)	SIZE (mm)	WORKING LOAD (kg)	QTY
17HF03-1M-TWTZ	A0652	1000	3	120	10
17HF03-2M-TWTZ	A1106	2000	3	120	10
17HF03-3M-TWTZ	A1105	3000	3	120	10



WIRE ROPE

WIRE ROPE



PART N°	SIZE (mm)	ROLL LENGTH	QTY
17CAT1-200	1	200m	1
17CAT2-100	2	100m	1
17CAT2-200	2	200m	1
17CAT2-250	2	250m	1
17CAT2-500	2	500m	1
17CAT2-1000	2	1000m	1
17CAT3-50	3	50m	1
17CAT3-100	3	100m	1
17CAT3-200	3	200m	1
17CAT3-250	3	250m	1
17CAT4-50	4	50m	1
17CAT4-100	4	100m	1
17CAT6-50	6	50m	1

WIRE AND CHAIN

COATED CATENARY WIRE ROPE



PART N°	ROLL LENGTH	QTY
17CATCOATED100	100m	1
17CATCOATED200	200m	1
17CATCOATED500	500m	1

CATENARY WIRE



PART N°	ROLL LENGTH	QTY
17CAT180	180m	1

JACK CHAIN - ZINC



PART N°	WORKING LOAD (KG)	MATERIAL SIZE (MM)	QTY
17JACK30	5	2.5	1

WIRE ROPE ACCESSORIES

ZIP-CLIP LOCK



PART N°	QF	SIZE (mm)	WORKING LOAD (kg)	QTY
17ZCR1	-	1	10	10
17ZCR2	A0578	2	50	10
17ZCR3	A0646	3	120	10
17ZCR4	A0674	4	230	10

ZIP-CLIP STRUT LOCK TRAPEZE DOME



PART N°	QF	SIZE (mm)	WORKING LOAD (kg)	QTY
17QF02SL	A0645	2	45	1

TURNBUCKLE



PART N°	FINISH	ENDS	QTY
17TB0676	ZINC	H-EYE	1
17TB0677	ZINC	H-EYE	1
17TB87014SS	SS	H-EYE	1
17TB87014SSEE	ZINC	EYE-EYE	1
17TB87015	ZINC	H-EYE	1
17TB87025	ZINC	H-EYE	1
17TB87025SS	SS	H-EYE	1
17TB87025SSEE	ZINC	EYE-EYE	1
17TB87045	ZINC	H-EYE	1
17TB8EEG	GALV	H-EYE	1
17TBM10125EE	ZINC	EYE-EYE	1
17TBM10150G	GALV	H-EYE	1

WIRE ROPE GRIP



PART N°	FINISH	SIZE	QTY
17WRGM3	ZINC	3MM	1
17WRGM3SS	SS	3MM	1
17WRGM4SS	SS	4MM	1
17WRGM5	ZINC	5MM	1
17WRGM6G	GALV	6MM	1
17WRGM8	ZINC	8MM	1

WIRE ROPE 45DEG BRACING BRACKET



PART N°	QF	QTY
17ZCB	A0702	100

WIRE ROPE DUCT CORNER



PART N°	QF	QTY
17DUCT	A0407	1000

WIRE ROPE ADAPTOR EYE BOLTS

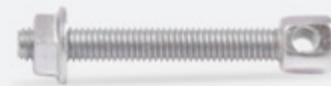

PART N°	QF	FINISH	THREAD SIZE	QTY
17HF-M6	A0426	ZINC	6	10
17HF-M8	A0427	ZINC	8	10

WIRE ROPE MALE EYE BOLTS



PART N°	FINISH	THREAD SIZE	QTY
12EBMM08	ZINC	M8	1
12EBMM10	ZINC	M10	1

WIRE ROPE FEMALE EYE BOLTS



PART N°	FINISH	THREAD SIZE	QTY
12ENFM10	ZINC	M10	1

WIRE ROPE STAINLESS STEEL EYE BOLTS



PART N°	FINISH	THREAD SIZE	QTY
12ENFM1055	SS	M10	1



GAS RISER SUPPORTS



FLOOR MOUNT GAS RISER SUPPORTS

SPRING HANGER ASSEMBLIES FOR FLOOR MOUNT GAS RISER SUPPORT - (A)

PART N°	QUICK	TO SUIT	FINISH	QTY
42GRSH32-FM	C1798	32CU	BROWN	1
42GRSH40-FM	C1800	40CU	BROWN	1
42GRSH50-FM	C1802	50CU	BROWN	1
42GRSH65-FM	C1804	65CU	BROWN	1
42GRSH80-FM	C1806	80CU	BROWN	1
42GRSH100-FM	C1792	100CU	BROWN	1
42GRSH125-FM	C1794	125CU	BROWN	1
42GRSH150-FM	C1796	150CU	BROWN	1

SLIDE GUIDE ASSEMBLIES FOR FLOOR MOUNT GAS RISER SUPPORT - (B)

PART N°	QUICK	TO SUIT	FINISH	QTY
42GRSG32-FM	C1782	32CU	BROWN	1
42GRSG40-FM	C1784	40CU	BROWN	1
42GRSG50-FM	C1786	50CU	BROWN	1
42GRSG65-FM	C1788	65CU	BROWN	1
42GRSG80-FM	C1790	80CU	BROWN	1
42GRSG100-FM	C1775	100CU	BROWN	1
42GRSG125-FM	C1777	125CU	BROWN	1
42GRSG150-FM	C1779	150CU	BROWN	1

FIXED POINT CLAMPS FOR FLOOR MOUNT GAS RISER SUPPORT - (C)

PART N°	QUICK	TO SUIT	FINISH	QTY
42GRFPC32-FM	C1765	32CU	BROWN	1
42GRFPC40-FM	C1767	40CU	BROWN	1
42GRFPC50-FM	C1769	50CU	BROWN	1
42GRFPC65-FM	C1771	65CU	BROWN	1
42GRFPC80-FM	C1773	80CU	BROWN	1
42GRFPC100-FM	C1756	100CU	BROWN	1
42GRFPC125-FM	C1758	125CU	BROWN	1
42GRFPC150-FM	C1760	150CU	BROWN	1

WALL MOUNT GAS RISER SUPPORTS

SPRING HANGER ASSEMBLIES FOR WALL MOUNT GAS RISER SUPPORT - (A)

PART N°	QUICK	TO SUIT	FINISH	QTY
42GRSH32-WM	C1799	32CU	BROWN	1
42GRSH40-WM	C1801	40CU	BROWN	1
42GRSH50-WM	C1803	50CU	BROWN	1
42GRSH65-WM	C1805	65CU	BROWN	1
42GRSH80-WM	C1807	80CU	BROWN	1
42GRSH100-WM	C1793	100CU	BROWN	1
42GRSH125-WM	C1795	125CU	BROWN	1
42GRSH150-WM	C1797	150CU	BROWN	1

SLIDE GUIDE ASSEMBLIES FOR WALL MOUNT GAS RISER SUPPORT - (B)

PART N°	QUICK	TO SUIT	FINISH	QTY
42GRSG32-WM	C1783	32CU	BROWN	1
42GRSG40-WM	C1785	40CU	BROWN	1
42GRSG50-WM	C1787	50CU	BROWN	1
42GRSG65-WM	C1789	65CU	BROWN	1
42GRSG80-WM	C1791	80CU	BROWN	1
42GRSG100-WM	C1776	100CU	BROWN	1
42GRSG125-WM	C1778	125CU	BROWN	1
42GRSG150-WM	C1780	150CU	BROWN	1

FIXED POINT CLAMPS FOR WALL MOUNT GAS RISER SUPPORT - (C)

PART N°	QUICK	TO SUIT	FINISH	QTY
42GRFPC32-WM	C1766	32CU	BROWN	1
42GRFPC40-WM	C1768	40CU	BROWN	1
42GRFPC50-WM	C1770	50CU	BROWN	1
42GRFPC65-WM	C1772	65CU	BROWN	1
42GRFPC80-WM	C1774	80CU	BROWN	1
42GRFPC100-WMH	C1757	100CU	BROWN	1
42GRFPC125-WM	C1759	125CU	BROWN	1
42GRFPC150-WM	C1761	150CU	BROWN	1



GAS RISER SUPPORTS - SLIDE GUIDES

SINGLE SLIDE GUIDE



PART N°	QUICK	THREAD SIZE	QTY
42127127	C1749	M10	25

SINGLE SLIDE GUIDE NO TABS



PART N°	QF	THREAD SIZE	QTY
42126755	C1747	M10	25

DOUBLE SLIDE GUIDE



PART N°	QF	THREAD SIZE	QTY
42127136	C1750	M10	25

DOUBLE SLIDE GUIDE NO TABS



PART N°	QF	THREAD SIZE	QTY
42126764	C1748	M10	25

HEAVY DUTY SINGLE SLIDE GUIDE



PART N°	QF	THREAD SIZE	QTY
42149301	C1755	M12	1

HEAVY DUTY SINGLE SLIDE GUIDE NO TABS



PART N°	QF	THREAD SIZE	QTY
42149295	C1754	M12	1

HEAVY DUTY DOUBLE SLIDE GUIDE



PART N°	QF	THREAD SIZE	QTY
42126658	C1745	M12	1

HEAVY DUTY DOUBLE SLIDE GUIDE NO TABS



PART N°	QF	THREAD SIZE	QTY
42126700	C1746	M12	1



WELDED NUTCLIPS

ISOCLIP NON-INSULATED



PART N°	QF	OUTSIDE DIA (mm)	FINISH	THREAD SIZE	QTY
16NS6065	C0588	60-65	ZINC	M10	100
16NS6771	C0589	67-71	ZINC	M10	50
16NS7482	C0590	74-82	ZINC	M10	50
16NS8289	C0591	82-89	ZINC	M10	50
16NS102109	C0575	102-109	ZINC	M10	30
16NS109117	C0576	109-117	ZINC	M10	50
16NS116125	C0577	116-125	ZINC	M10	50
16NS129141	C0578	129-141	ZINC	M10	50
16NS142154	C0579	142-154	ZINC	M10	25
16NS158169	C0580	158-169	ZINC	M10	30
16NS166177	C0581	166-177	ZINC	M10	20
16NS201212	C0583	201-212	ZINC	M10	15

PIPE WELDED NUTCLIP - ZINC



PIPE WELDED NUTCLIP - ZINC - M10

PART N°	QF	TO SUIT	OUTSIDE DIA (mm)	FINISH	THREAD SIZE	QTY
16WNB15	C0919	15NB	21	ZINC	M10	50
16WNB20	C0922	20NB	27	ZINC	M10	50
16WNB25	C0924	25NB	34	ZINC	M10	50
16WNB32	C0926	32NB	43	ZINC	M10	50
16WNB40	C0927	40NB	48	ZINC	M10	50
16WNB50	C0928	50NB	60	ZINC	M10	50
16WNB65	C0929	65NB	76	ZINC	M10	25
16WNB80	C0931	80NB	89	ZINC	M10	25
16WNB100	C0916	100NB	114	ZINC	M10	20
16WNB125	C0918	125NB	140	ZINC	M10	20
16WNB150	C0920	150NB	165	ZINC	M10	20

PIPE WELDED NUTCLIP - ZINC - M12

PART N°	QF	TO SUIT	OUTSIDE DIA (mm)	FINISH	THREAD SIZE	QTY
16WNB6512	C0930	65NB	76	ZINC	M12	25
16WNB8012	C0932	80NB	89	ZINC	M12	25
16WNB10012	C0917	100NB	114	ZINC	M12	20
16WNB15012	C0921	150NB	165	ZINC	M12	20
16WNB20012	C0923	200NB	219	ZINC	M12	10

HDPE PIPE WELDED NUTCLIP - POWDER COATED BLACK



HDPE PIPE WELDED NUTCLIP - POWDER COATED - M10

PART N°	QF	TO SUIT	FINISH	THREAD SIZE	QTY
16WNH40	C0962	40HDPE	BLACK	M10	50
16WNH50	C0963	50HDPE	BLACK	M10	50
16WNH56	C0964	56HDPE	BLACK	M10	50
16WNH63	C0965	63HDPE	BLACK	M10	50
16WNH75	C0966	75HDPE	BLACK	M10	50
16WNH90	C0967	90HDPE	BLACK	M10	50
16WNH110	C0950	110HDPE	BLACK	M10	25
16WNH12510	C0951	125HDPE	BLACK	M10	25
16WNH16010	C0953	160HDPE	BLACK	M10	25

HDPE PIPE WELDED NUTCLIP - POWDER COATED - M12

PART N°	QF	TO SUIT	FINISH	THREAD SIZE	QTY
16WNH12512	C0952	125HDPE	BLACK	M12	25
16WNH16012	C0955	160HDPE	BLACK	M12	10
16WNH20012	C0957	200HDPE	BLACK	M12	10
16WNH25012	C0959	250HDPE	BLACK	M12	10
16WNH31512	C0961	315HDPE	BLACK	M12	10

HDPE XL ULTRA PIPE WELDED NUTCLIP - POWDER COATED - M12

PART N°	QF	TO SUIT	FINISH	THREAD SIZE	QTY
16WNHU20012	C0968	200HDPE	BLACK	M12	10
16WNHU25012	C0969	250HDPE	BLACK	M12	10
16WNHU31512	C0970	315HDPE	BLACK	M12	10

PVC PIPE WELDED NUTCLIP - POWDER COATED WHITE



PVC PIPE WELDED NUTCLIP - POWDER COATED WHITE - M10

PART N°	QF	TO SUIT	OUTSIDE DIA (mm)	FINISH	THREAD SIZE	QTY
16WNP40	C0977	40PVC	43	WHITE	M10	50
16WNP50	C0978	50PVC	56	WHITE	M10	50
16WNP65	C0979	65PVC	69	WHITE	M10	50
16WNP80	C0980	80PVC	83	WHITE	M10	50
16WNP100	C0971	100PVC	110	WHITE	M10	25
16WNP150	C0972	150PVC	160	WHITE	M10	25
16WNP22510	C0973	225PVC	250	WHITE	M10	25
16WNP30010	C0975	300PVC	315	WHITE	M10	10

PVC PIPE WELDED NUTCLIP - POWDER COATED WHITE - M12

PART N°	QF	TO SUIT	OUTSIDE DIA (mm)	FINISH	THREAD SIZE	QTY
16WNP22512	C0974	225PVC	250	WHITE	M12	15
16WNP30012	C0976	300PVC	315	WHITE	M12	10



COPPER PIPE WELDED NUTCLIP - POWDER COATED BROWN



COPPER PIPE WELDED NUTCLIP - POWDER COATED - M10

PART N°	QF	TO SUIT	FINISH	THREAD SIZE	QTY
16WNC15	C0936	15CU	BROWN	M10	50
16WNC20	C0940	20CU	BROWN	M10	50
16WNC25	C0943	25CU	BROWN	M10	50
16WNC32	C0944	32CU	BROWN	M10	50
16WNC40	C0945	40CU	BROWN	M10	50
16WNC50	C0946	50CU	BROWN	M10	50
16WNC65	C0947	65CU	BROWN	M10	50
16WNC80	C0948	80CU	BROWN	M10	50
16WNC10010	C0933	100CU	BROWN	M10	25
16WNC125	C0935	125CU	BROWN	M10	25
16WNC15010	C0937	150CU	BROWN	M10	25
16WNC20010	C0941	200CU	BROWN	M10	15

COPPER PIPE WELDED NUTCLIP - POWDER COATED - M12

PART N°	QF	TO SUIT	FINISH	THREAD SIZE	QTY
16WNC8012	C0949	80CU	BROWN	M12	50
16WNC10010	C0933	100CU	BROWN	M12	25
16WNC15012	C0938	150CU	BROWN	M12	25
16WNC20012	C0942	200CU	BROWN	M12	15

ADJUSTABLE ALLTHREAD CLIPS

ADJUSTABLE ALLTHREAD CLIPS - POWDER COATED - M10



PART N°	TO SUIT	OUTSIDE DIA. (mm)	FINISH	THREAD SIZE	QTY
16ADJ40P	40PVC	43	WHITE	M10	25
16ADJ50P	50PVC	56	WHITE	M10	25
16ADJ65P	65PVC	69	WHITE	M10	25
16ADJ80P	80PVC	83	WHITE	M10	25
16ADJ100P	100PVC	110	WHITE	M10	25
16ADJ150P	150PVC	160	WHITE	M10	10
16ADJ-225-PVC-PPC	225PVC	250	WHITE	M10	10
16ADJ-300-PVC-PPC	300PVC	315	WHITE	M10	10

PIPE HANGERS

YOKE ADJUSTABLE



PIPE HANGERS - YOKE ADJUSTABLE - PVC

PART N°	MATERIAL SIZE (mm)	TO SUIT	ACTUAL SIZE (mm)	FINISH	QTY
16ADJ-040-PVC-HDG	20 x 3	40PVC	43	GAL	25
16ADJ-050-PVC-HDG	20 x 3	50PVC	56	GAL	25
16ADJ-080-PVC-HDG	20 x 3	80PVC	82.3	GAL	25
16ADJ-090-PVC-HDG	20 x 3	90PVC	90	GAL	25
16ADJ-100-PVC-HDG	25 x 3	100PVC	110	GAL	25
16ADJ-150-PVC-HDG	-	150PVC	160	GAL	25
16ADJ-300-PVC-HDG	-	300PVC	315	GAL	25
16ADJ-350-PVC-HDG	-	350PVC	356	GAL	25

YOKE ADJUSTABLE MEDIUM DUTY



PART N°	MATERIAL SIZE (mm)	TO SUIT	ACTUAL SIZE (mm)	FINISH	QTY
16ERIC18-60	40 x 6	50NB	60	HDG	25
16ERIC18-76	40 x 6	65NB	76	HDG	25
16ERIC18-89	40 x 6	80NB	89	HDG	25
16ERIC18-102	40 x 6	100CU	102	HDG	25
16ERIC18-114	40 x 6	100NB	114	HDG	25
16ERIC18-152	40 x 6	150CU	152	HDG	25
16ERIC18-165	40 x 6	150NB	165	HDG	25
16ERIC18-175	40 x 6	175MM	175	HDG	25
16ERIC18-219	40 x 6	200NB	219	HDG	25
16ERIC18-252	40 x 6	225PVC	250	HDG	25
16ERIC18-273	40 x 6	250NB	273	HDG	25

PIPE HANGER ACCESSORIES



PART N°	ANGLE	FINISH	QTY
19NC45B	Angle Bracket - 45 DEGREE	20 x 3	25
19NC90B	Angle Bracket - 90 DEGREE	20 x 3	25



SureFIX

PIPE CLAMPS

SureFix ISO Clips are double screw clamps for suspending all pipes with a unique rubber insulation design to prevent rolling and binding. Unmatched performance for all pipes including: PVC, HDPE, Copper, Steel and PEX.



Features

- Unique rubber design to prevent rolling and binding which allows pipes to slide on installation
- EPDM isolation rubber for sound reduction up to 15Db (DIN4109)
- High strength engineered Steel Profile design
- M8-M10 Combination Nut for connection
- Plastic shake proof washer prevents bolts falling out on installation
- Finish: 8-12micron Electro-zinc plating

Applications

Recommended for the suspension and support of stationary pipelines where noise reduction is required in both vertical and horizontal application.

- To suit all pipes from 12 mm to 168 mm including PVC, HDPE, Copper, Steel and Pex
- Temperature rating from -50°C up to +110°C

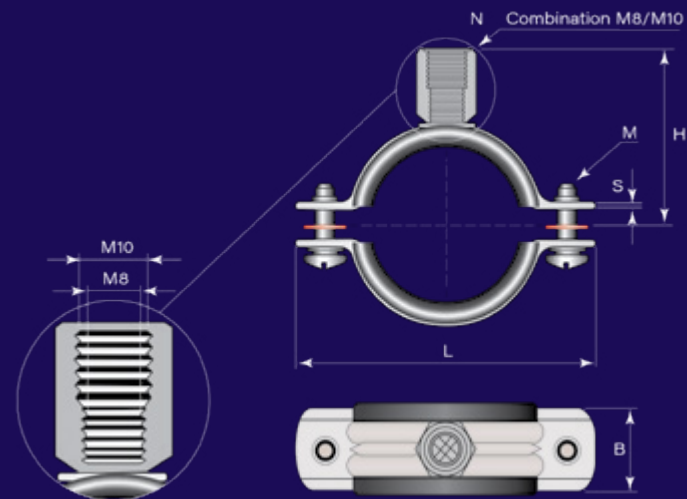



RUBBER LINED NUTCLIPS

ISOCLIP INSULATED

Zinc brackets pictured.



Stainless steel brackets
also available in all sizes.

PART N°	QF	TO SUIT	OUTSIDE DIA (mm)	FINISH	THREAD SIZE	QTY
16ISO1320	C0493	15CU	13-20	ZINC	M10	250
16ISO1723	C0496	20CU	17-23	ZINC	M10	250
16ISO2630	C0497	25CU	26-30	ZINC	M10	150
16ISO3034	C0498	32CU	33-37	ZINC	M10	150
16ISO3640	C0499	40CU	40-46	ZINC	M10	100
16ISO4046	-	40PVC	40-46	ZINC	M10	100
16ISO4853	-	50PVC	53-59	ZINC	M10	75
16ISO5359	C0501	50PVC	53-59	ZINC	M10	75
16ISO6066	C0502	65CU	60-66	ZINC	M10	50
16ISO6777	C0503	65PVC	67-77	ZINC	M10	60
16ISO7484	C0504	80CU	75-84	ZINC	M10	60
16ISO8393	C0505	80PVC	83-93	ZINC	M10	40
16ISO94104	C0506	100CU	94-104	ZINC	M10	50
16ISO109119	C0491	100PVC	109-119	ZINC	M10	50
16ISO151164	C0494	150CU	151-164	ZINC	M10	25
16ISO158170	C0495	150PVC	158-170	ZINC	M10	25

HEAVY DUTY PIPE CLAMPS

HEAVY DUTY TWO PIECE PIPE CLAMP



PART N°	QF	TO SUIT	OUTSIDE DIA (mm)	FINISH	MATERIAL SIZE (mm)	BOLT SIZE	QTY
18HM16-21	C0985	15NB	21	HDG	25 x 3	M8 x 25	1
18HM16-27	C0987	20NB	27	HDG	25 x 3	M8 x 25	1
18HM16-34	C0990	25NB	34	HDG	25 x 3	M8 x 25	1
18HM16-43	C0992	32NB	43	HDG	25 x 3	M8 x 25	1
18HM16-48	C0993	40NB	48	HDG	32 x 5	M12 x 40	1
18HM16-60	C0994	50NB	60	HDG	40 x 6	M12 x 40	1
18HM16-76	C0995	65NB	76	HDG	40 x 6	M12 x 40	1
18HM16-89	C0996	80NB	89	HDG	40 x 6	M12 x 40	1
18HM16-114	C0981	100NB	114	HDG	40 x 6	M12 x 40	1
18HM16-140	C0982	125NB	140	HDG	40 x 6	M12 x 40	1
18HM16-165	C0983	150NB	165	HDG	40 x 6	M12 x 40	1
18HM16-219	C0986	200NB	219	HDG	40 x 6	M12 x 40	1
18HM16-273	C0988	250NB	273	HDG	40 x 6	M12 x 40	1
18HM16-324	C0989	300NB	324	HDG	40 x 6	M12 x 40	1
18HM16-400	C0991	375PVC	400	HDG	40 x 6	M12 x 40	1

DOWNPIPE BRACKETS

STAINLESS STEEL TIMBER AND MASONRY CLIP HEAD



PART N°	TO SUIT	OUTSIDE DIA (mm)	FINISH	QTY
16TMB90PSSCH	90PVC	90	SS	1
16TMB100PSSCH	100PVC	110	SS	1
16TMB150PSSCH	150PVC	160	SS	1

STAINLESS STEEL TIMBER AND MASONRY PIPE BRACKET



PART N°	TO SUIT	OUTSIDE DIA (mm)	FINISH	QTY
16TMB50PSS	50PVC	56	SS	1
16TMB65PSS	65PVC	69	SS	1
16TMB75PSS	75PVC	75	SS	1
16TMB80PSS	80PVC	83	SS	1
16TMB90PSS	90PVC	90	SS	1
16TMB100PSS	100PVC	110	SS	1
16TMB150PSS	150PVC	160	SS	1



FIRE SERVICE CLAMPS

U-BOLT



* Refer page 25 for U-Bolt Cleats.

PART N°	QF	TO SUIT	OUTSIDE DIA (mm)	FINISH	THREAD SIZE	QTY
18UB0625	C0997	25NB	34	ZINC	M6	50
18UB0632	C0998	32NB	43	ZINC	M6	50
18UB1015	C0999	15NB	21	HDG	M10	50
18UB1020	C1000	20NB	27	HDG	M10	50
18UB1025	C1001	25NB	34	HDG	M10	50
18UB1032	C1002	32NB	43	HDG	M10	50
18UB1040	C1003	40NB	48	HDG	M10	50
18UB1050	C1004	50NB	60	HDG	M10	50
18UB1265	C1008	65NB	76	HDG	M12	50
18UB1280	C1009	80NB	89	HDG	M12	25
18UB12100	C1005	100NB	114	HDG	M12	10
18UB0625	C1006	125NB	140	HDG	M12	10
18UB0632	C1007	150NB	165	HDG	M12	10
18UB16200	C1010	200NB	219	HDG	M16	10

TWIST CLIP



PART N°	QF	TO SUIT	OUTSIDE DIA (mm)	FINISH	QTY
16CTC 25	C0403	25NB	27	ZINC	250
16CTC 32	C0404	32NB	34	ZINC	250
16CTC 40	C0405	40NB	43	ZINC	200
16CTC 50	C0406	50NB	60	ZINC	100
16CTC 65	C0407	65NB	76	ZINC	100

SINGLE PIECE CLIP



PART N°	QF	TO SUIT	OUTSIDE DIA (mm)	FINISH	QTY
16SPC25	C0884	25NB	34	ZINC	300
16SPC32	C0885	32NB	43	ZINC	250
16SPC40	C0886	40NB	48	ZINC	200
16SPC50	C0887	50NB	60	ZINC	150

PEAR BAND



PART N°	QF	TO SUIT	OUTSIDE DIA (mm)	HOLE SIZE (mm)	QTY
16PB27	C0613	20NB	27	11	50
16PB 34	C0615	25NB	34	11	100
16PB 43	C0616	32NB	43	11	100
16PB 48	C0618	40NB	48	11	100
16PB 60	C0620	50NB	60	11	100
16PB 76	C0622	65NB	76	13	50
16PB 89	C0624	80NB	89	13	50
16PB 114	C0608	100NB	114	13	50
16PB 165	C0610	150NB	165	13	25
16PB220	C0611	200NB	219	17	10
16PB273	C0614	250NB	273	18	1



STAND OFF SADDLES

STAND OFF SADDLE



PART N°	QF	TO SUIT	OUTSIDE DIA (mm)	FINISH	QTY
16PVCSOS040	C0740	40PVC	43	WHITE	25
16PVCSOS050	C0741	50PVC	56	WHITE	25
16PVCSOS065	C0742	65PVC	69	WHITE	25
16PVCSOS100	C0743	100PVC	110	WHITE	25

STAND OFF BRACKETS

STAND OFF BRACKET



PART N°	QF	TO SUIT	OUTSIDE DIA (mm)	FINISH	QTY
16SOB40P	C0857	40PVC	43	WHITE	25
16SOB50P	C0858	50PVC	56	WHITE	25
16SOB65P	C0859	65PVC	69	WHITE	25
16SOB80P		80PVC	85	WHITE	25
16SOB100P	C0860	100PVC	110	WHITE	25

STAINLESS CLAMPS

STAINLESS STEEL NUTCLIP



PART N°	QF	TO SUIT	OUTSIDE DIA (mm)	THREAD SIZE	QTY
16NUT-032-CU-SS	C0593	32HDPE	32	M10	1
16NUT-040-CU-SS	C0594	40HDPE	38	M10	1
16NUT-040-PVC-SS	C0595	40PVC	43	M10	1
16NUT-050-CU-SS	C0596	50HDPE	51	M10	1
16NUT-050-PVC-SS	C0597	50PVC/56HDPE	56	M10	1
16NUT-065-CU-SS	C0598	63HDPE	63	M10	1
16NUT-065-PVC-SS	C0599	60PVC	69	M10	1
16NUT-080-CU-SS	C0600	75HDPE	76	M10	1
16NUT-080-PVC-SS	C0602	80PVC	83	M10	1
16NUT-100-PVC-SS	C0603	100PVC/110HDPE	110	M10	1
16NUT-125-CU-SS	C0604	125HDPE	127	M10	1
16NUT-150-PVC-SS	C0605	150PVC/160HDPE	160	M10	1

STAINLESS STEEL SINGLE PIECE CLIP



PART N°	QF	TO SUIT	OUTSIDE DIA (mm)	HOLE SIZE (mm)	QTY
16SPC-032-CU-SS	C0867	32HDPE	32	8	1
16SPC-040-CU-SS	C0868	40HDPE	38	8	1
16SPC-040-PVC-SS	C0869	40PVC	43	8	1
16SPC-050-CU-SS	C0870	50HDPE	51	8	1
16SPC-050-PVC-SS	C0871	50PVC/56HDPE	56	8	1
16SPC-065-CU-SS	C0872	63HDPE	63	8	1
16SPC-065-PVC-SS	C0873	65PVC	69	8	1
16SPC-080-CU-SS	C0874	75HDPE	76	8	1
16SPC-080-PVC-SS	C0875	80PVC	83	8	1
16SPC-100-PVC-SS	C0877	100PVC/110HDPE	110	8	1
16SPC-125-CU-SS	C0878	125HDPE	127	8	1
16SPC-150-PVC-SS	C0879	150PVC/160HDPE	160	8	1
16SPC-200-CU-SS	C0880	200HDPE	203	8	1
16SPC-225-PVC-SS	C0881	225PVC/250HDPE	250	8	1
16SPC-300-PVC-SS	C0882	300PVC/315HDPE	315	8	1



CLIP HEADS

PVC CLIP HEAD



PART N°	QF	TO SUIT	OUTSIDE DIA (mm)	FINISH	QTY
16PVCDN40	C0729	40PVC	43	WHITE	20
16PVCDN50	C0730	50PVC	56	WHITE	20
16PVCDN65	C0731	65PVC	69	WHITE	20
16PVCDN80	C0732	80PVC	83	WHITE	20
16PVCDN90	C0733	90PVC	89	WHITE	20
16PVCDN100	C0726	100PVC	110	WHITE	20
16PVCDN150	C0727	150PVC	160	WHITE	20

PRESSURE PVC CLIP HEAD



PART N°	QF	TO SUIT	OUTSIDE DIA (mm)	FINISH	QTY
16PRESSDN15	C0714	15PPVC	21	WHITE	20
16PRESSDN20	C0715	20PPVC	27	WHITE	20
16PRESSDN25	C0716	25PPVC	34	WHITE	20
16PRESSDN32	C0717	32PPVC	43	WHITE	20

PVC EXPANSION CLIP HEAD



PART N°	QF	TO SUIT	FINISH	QTY
16EXPDN50	C0426	50PVC EXP	WHITE	20
16EXPDN65	C0427	65PVC EXP	WHITE	20
16EXPDN80	C0428	80PVC EXP	WHITE	20
16EXPDN100	C0425	100PVC EXP	WHITE	20

WELDED NUT BRACKET



PART N°	QF	THREAD SIZE	QTY
160063	C0322	M10	50

NUMBER 7 HANGER BRACKET



PART N°	QF	TO SUIT	QTY
16NO7HB	C0543	M10	50

COPPER CLIP HEAD



PART N°	QF	TO SUIT	FINISH	QTY
16CUDN15	C0409	15CU	BROWN	20
16CUDN20	C0410	20CU	BROWN	20
16CUDN25	C0411	25CU	BROWN	20
16CUDN32	C0412	32CU	BROWN	20
16CUDN40	C0413	40CU	BROWN	20
16CUDN50	C0414	50CU	BROWN	20
16CUDN65	C0415	65CU	BROWN	20
16CUDN80	C0416	80CU	BROWN	20

ADJUSTABLE STAND OFF BRACKET



PART N°	QF	FINISH	QTY
160080	-	ZINC	50
160080	C0323	ZINC	50
160080SS	C0324	SS	50

LIGHT HANGING BRACKET



PART N°	QF	LENGTH (mm)	FINISH	QTY
160059	C0319	300	ZINC	50

STAND OFF T-BRACKET



PART N°	QF	FINISH	QTY
160060	C0320	ZINC	50
160060SS	C0321	SS	50



STRUT CLIPS

ZINC STRUT CLIPS



ZINC STRUT CLIPS FOR COPPER PIPE - WITH CUSHION

PART N°	TO SUIT	ACTUAL SIZE (mm)	FINISH	QTY
19SCZ017	15CU	17	ZINC	100
19SCZ023	20CU	23	ZINC	100
19SCZ029	25CU	29	ZINC	100
19SCZ034	32CU	34	ZINC	100
19SCZ041	40CU	41	ZINC	100
19SCZ054	50CU	54	ZINC	100
19SCZ067	65CU	67	ZINC	50
19SCZ079	80CU	79	ZINC	50
19SCZ105	100CU	105	ZINC	50
19SCZ129	125CU	129	ZINC	50
19SCZ152	150CU	152	ZINC	50
19SCZ178	175CU	178	ZINC	50
19SCZ203	200CU	203	ZINC	25
19SCZ228	225CU	228	ZINC	25
19SCZ302	300CU	102	ZINC	25
19SCZ356	355CU	356	ZINC	25

ZINC STRUT CLIPS FOR COPPER PIPE - WITHOUT CUSHION

PART N°	TO SUIT	ACTUAL SIZE (mm)	FINISH	QTY
19SCZ013	15CU	13	ZINC	100
19SCZ019	20CU	19	ZINC	100
19SCZ025	25CU	25	ZINC	100
19SCZ032	32CU	32	ZINC	100
19SCZ038	40CU	38	ZINC	100
19SCZ051	50CU	51	ZINC	100
19SCZ064	65CU	64	ZINC	50
19SCZ076	80CU	76	ZINC	50
19SCZ102	100CU	102	ZINC	50
19SCZ127	125CU	127	ZINC	50
19SCZ152	150CU	152	ZINC	50
19SCZ178	175CU	178	ZINC	50
19SCZ203	200CU	203	ZINC	25
19SCZ228	225CU	228	ZINC	25
19SCZ302	300CU	302	ZINC	25
19SCZ356	355CU	356	ZINC	25

ZINC STRUT CLIPS FOR STEEL PIPE

PART N°	TO SUIT	ACTUAL SIZE (mm)	FINISH	QTY
19SCZ021	15NB	21	ZINC	100
19SCZ027	20NB	27	ZINC	100
19SCZ034	25NB	34	ZINC	100
19SCZ043	32NB	43	ZINC	100
19SCZ048	40NB	48	ZINC	100
19SCZ060	50NB	60	ZINC	50
19SCZ076	65NB	76	ZINC	50
19SCZ089	80NB	89	ZINC	50
19SCZ114	100NB	114	ZINC	50
19SCZ140	125NB	140	ZINC	50
19SCZ165	150NB	165	ZINC	50
19SCZ219	200NB	213	ZINC	25
19SCZ275	250NB	275	ZINC	25
19SCZ324	300NB	324	ZINC	25
19SCZ406	400NB	406	ZINC	25

ZINC STRUT CLIPS FOR PVC PIPE

PART N°	TO SUIT	ACTUAL SIZE (mm)	FINISH	QTY
19SCZ043	40PVC	43	ZINC	100
19SCZ056	50PVC	56	ZINC	50
19SCZ070	65PVC	69	ZINC	50
19SCZ083	80PVC	82	ZINC	50
19SCZ110	100PVC	110	ZINC	50
19SCZ160	150PVC	160	ZINC	50
19SCZ250	225PVC	250	ZINC	25
19SCZ315	300PVC	315	ZINC	25

STAINLESS STEEL STRUT CLIPS



Stainless steel strut clips also available in all sizes.



HOT-DIP GALVANISED STRUT CLIPS



HDG STRUT CLIPS FOR COPPER PIPE - WITH CUSHION

PART N°	TO SUIT	ACTUAL SIZE (mm)	FINISH	QTY
19SCH017	15CU	16	HDG	100
19SCH023	20CU	22	HDG	100
19SCH029	25CU	29	HDG	100
19SCH034	32CU	35	HDG	100
19SCH041	40CU	41	HDG	100
19SCH054	50CU	54	HDG	50
19SCH067	65CU	67	HDG	50
19SCH079	80CU	79	HDG	50
19SCH105	100CU	104	HDG	50
19SCH129	125CU	129	HDG	50
19SCH152	150CU	152	HDG	50
19SCH178	175CU	178	HDG	50
19SCH203	200CU	202	HDG	25
19SCH228	225CU	228	HDG	25
19SCH302	300CU	303	HDG	25

HDG STRUT CLIPS FOR COPPER PIPE - WITHOUT CUSHION

PART N°	TO SUIT	ACTUAL SIZE (mm)	FINISH	QTY
19SCH013	15CU	13	HDG	100
19SCH019	20CU	19	HDG	100
19SCH025	25CU	25	HDG	100
19SCH032	32CU	32	HDG	100
19SCH038	40CU	38	HDG	100
19SCH051	50CU	51	HDG	50
19SCH064	65CU	64	HDG	50
19SCH076	80CU	76	HDG	50
19SCH102	100CU	102	HDG	50
19SCH127	125CU	127	HDG	50
19SCH152	150CU	152	HDG	50
19SCH178	175CU	178	HDG	50
19SCH203	200CU	203	HDG	25
19SCH228	225CU	228	HDG	25
19SCH302	300CU	302	HDG	25

HOT-DIP GALVANISED STRUT CLIPS FOR STEEL PIPE

PART N°	TO SUIT	ACTUAL SIZE (mm)	FINISH	QTY
19SCH021	15NB	21	HDG	100
19SCH027	20NB	26.9	HDG	100
19SCH034	25NB	34	HDG	100
19SCH043	32NB	42.4	HDG	100
19SCH048	40NB	48.3	HDG	100
19SCH060	50NB	60	HDG	50
19SCH076	65NB	76	HDG	50
19SCH089	80NB	89	HDG	50
19SCH114	100NB	114	HDG	50
19SCH140	125NB	140	HDG	50
19SCH165	150NB	165	HDG	50
19SCH219	200NB	219	HDG	25
19SCH275	250NB	273	HDG	25
19SCH324	300NB	324	HDG	25

HOT-DIP GALVANISED STRUT CLIPS FOR PVC PIPE

PART N°	TO SUIT	ACTUAL SIZE (mm)	FINISH	QTY
19SCH043	40PVC	43	HDG	100
19SCH056	50PVC	56	HDG	50
19SCH070	65PVC	69	HDG	50
19SCH083	80PVC	82	HDG	50
19SCH110	100PVC	110	HDG	50
19SCH160	150PVC	160	HDG	50
19SCH250	225PVC	250	HDG	25
19SCH315	300PVC	315	HDG	25

POWDER COATED STRUT CLIPS FOR COPPER PIPE



PART N°	QF	TO SUIT	FINISH	QTY
15CU	19SCP013	12.7	BROWN	100
20CU	19SCP019	19	BROWN	100
25CU	19SCP025	26	BROWN	100
32CU	19SCP032	32	BROWN	100
40CU	19SCP038	38	BROWN	100
50CU	19SCP051	51	BROWN	50
65CU	19SCP064	64	BROWN	50
80CU	19SCP076	76	BROWN	50
100CU	19SCP102	102	BROWN	50



STRUT CLIP ACCESSORIES

ISOLATION STRIP FOR STRUT CLIPS



Please Note: 20 meter roll.

PART N°	WIDTH (mm)	ROLL LENGTH (m)	TO SUIT	QTY
19CUSHION	42	20	STRUT CLIPS	1

FLAT RUBBER FOR STRUT CLIPS



PART N°	QF	WIDTH (mm)	QTY
19RUB-FLAT	C1098	38	25

LIP RUBBER FOR STRUT CLIPS



PART N°	QF	QTY
19RUB-LIP	C1099	25

BARRIER STRIP FOR STRUT CLIPS



Please Note: Pack of 100

PART N°	QF	QTY
19CHCBS	C1078	1

REFRIGERATION CLIPS

CUSHION CLAMP



PART N°	QF	TO SUIT	OUTSIDE DIA (mm)	QTY
19CHC-B6274	C1022	3/8CU	10	10
19CHC-B6267	C1013	1/2CU	13	10
19CHC-B6276	C1024	5/8CU	16	10
19CHC-B6273	C1021	3/4CU	19	10
19CHC-B6277	C1025	7/8CU	22	10
19CHC-B6264	C1012	1-1/8CU	28	10
19CHC-B6265	C1014	1-3/8CU	35	10
19CHC-B6266	C1016	1-5/8CU	42	10
19CHC-B6269	C1018	2-1/8CU	54	10



PIPE SADDLES

GALVANISED PIPE SADDLE



PART N°	QF	TO SUIT	OUTSIDE DIA (mm)	FINISH	QTY
16CLS 15	C0395	15NB/PPVC	21	ZINC	100
16CLS 20	C0397	20NB/PPVC	27	ZINC	100
16CLS 25	C0398	25NB/PPVC	34	ZINC	100
16CLS 32	C0399	32NB/PPVC	43	ZINC	100
16CLS 40	C0400	40NB/PPVC	48	ZINC	100
16CLS 50	C0401	50NB/PPVC	60	ZINC	100

COPPER PIPE SADDLE



PART N°	QF	TO SUIT	OUTSIDE DIA (mm)	FINISH	QTY
16DN15	C0417	15CU	12.7	BROWN	200
16DN20	C0419	20CU	19	BROWN	200
16DN25	C0420	25CU	25.4	BROWN	200
16DN32	C0421	32CU	31.8	BROWN	20
16DN40	C0422	40CU	38.1	BROWN	20
16DN50	C0423	50CU	51.2	BROWN	20
16DN65	C0424	65CU	63.5	BROWN	20

VELOX HALF SADDLE - TIMBER SCREW



PART N°	QF	SIZE (mm)	QTY
40SAD14877	C1594	16	100
40SAD14878	C1595	20	100
40SAD15650	C1596	25	100

PVC PIPE SADDLE



PART N°	QF	TO SUIT	OUTSIDE DIA (mm)	FINISH	QTY
16PVCSAD40	C0736	40PVC	43	WHITE	50
16PVCSAD50	C0737	50PVC	56	WHITE	50
16PVCSAD65	C0738	65PVC	69	WHITE	50
16PVCSAD80	C0739	80PVC	83	WHITE	25
16PVCSAD100	C0734	100PVC	110	WHITE	25
16PVCSAD150	C0735	150PVC	160	WHITE	25

VELOX HALF SADDLE - MASONRY NAIL



PART N°	QF	SIZE (mm)	QTY
40SAD11040	C1591	16	100
40SAD11041	C1592	20	100
40SAD11061	C1593	25	100

PRESSURE PVC PIPE SADDLE



PART N°	QF	TO SUIT	OUTSIDE DIA (mm)	FINISH	QTY
16PRESSAD15	C0720	15PPVC	21	WHITE	100
16PRESSAD20	C0721	20PPVC	27	WHITE	100
16PRESSAD25	C0722	25PPVC	34	WHITE	100
16PRESSAD32	C0723	32PPVC	43	WHITE	100

VELOX HALF SADDLE - METAL SCREW



PART N°	QF	SIZE (mm)	QTY
40SAD11043	C1588	16	100
40SAD11044	C1589	20	100
40SAD11064	C1590	25	100



FERRULES

TIMBER FERRULE



Steel sizes also available.

25MM TIMBER FERRULE

PART N°	QUICK	LENGTH (mm)	TO SUIT	OUTSIDE DIAMETER (mm)	WALL THICKNESS (mm)	QTY
16FER-012-25TMB	C0625	45	15CU	64	25	10
16FER-020-25TMB	C0627	45	20CU	69	25	10
16FER-025-25TMB	C0629	45	25CU	76	25	10
16FER-032-25TMB	C0632	45	32CU	83	25	10
16FER-040-25TMB	C0635	45	40CU	89	25	10
16FER-050-25TMB	C0638	45	50CU	102	25	10
16FER-065-25TMB	C0641	45	65CU	114	25	10
16FER-080-25TMB	C0644	45	80CU	127	25	10
16FER-100-25TMB	C0648	45	100CU	152	25	10
16FER-125-25TMB	C0651	45	125CU	178	25	10
16FER-150-25TMB	C0654	45	150CU	203	25	10

38MM TIMBER FERRULE

PART N°	QUICK	LENGTH (mm)	TO SUIT	OUTSIDE DIAMETER (mm)	WALL THICKNESS (mm)	QTY
16FER-015-38TMB	C0626	45	15CU	89	38	10
16FER-020-38TMB	C0628	45	20CU	102	38	10
16FER-025-38TMB	C0630	45	25CU	102	38	10
16FER-032-38TMB	C0633	45	32CU	102	38	10
16FER-040-38TMB	C0636	45	40CU	114	38	10
16FER-050-38TMB	C0639	45	50CU	127	38	10
16FER-065-38TMB	C0642	45	65CU	140	38	10
16FER-080-38TMB	C0645	45	80CU	152	38	10
16FER-100-38TMB	C0649	45	100CU	178	38	10
16FER-125-38TMB	C0652	45	125CU	203	38	10
16FER-150-38TMB	C0655	45	150CU	228	38	10
16FER-200-38TMB	C0658	45	200CU	273	38	10

50MM TIMBER FERRULE

PART N°	QUICK	LENGTH (mm)	TO SUIT	OUTSIDE DIAMETER (mm)	WALL THICKNESS (mm)	QTY
16FER-032-50TMB	C0634	45	32CU	140	50	10
16FER-040-50TMB	C0637	45	40CU	140	50	10
16FER-050-50TMB	C0640	45	50CU	152	50	10
16FER-065-50TMB	C0643	45	65CU	165	50	10
16FER-080-50TMB	C0646	45	80CU	178	50	10
16FER-100-50TMB	C0650	45	100CU	203	50	10
16FER-125-50TMB	C0653	45	125CU	228	50	10
16FER-150-50TMB	C0656	45	150CU	254	50	10
16FER-200-50TMB	C0659	45	200CU	303	50	10
16FER-250-50TMB	C0660	45	250CU	356	50	10
16FER-300-50TMB	C0661	45	300CU	400	50	10



Poly Ferrules

Acura Poly Ferrules have been developed to provide efficient insulation and pipe clamp support on systems operating above or below ambient temperatures. Poly Ferrules bring many energy and space saving benefits to the insulation of heating and chilled water systems.

Constructed from polyurethane with a foil outer layer. To be used in conjunction with a Nutclip or Strut Clip for the suspension of services where pipe insulation is required.



Environmentally Friendly

For the ultimate in pipe support technology, Acura Poly Ferrules surpass even the highest standards. Environmentally sound, this user-friendly product maximizes your commitment to sustainability.

Boasting a green star rating and a Volatile Organic Compound (VOC) of zero, its insulating properties are also rated greater than 5. High stress foil vapour seal encapsulates the rigid yet lightweight structure.

Contractors Choice

Acura Poly Ferrules are resistant to fire at DIN 4102 B3 and have a temperature rating that sits between -50°C and 95°C.

This truly is the contractors' choice if efficiency and value are central to your needs.

High stress foil vapour seal

Green Star Rated

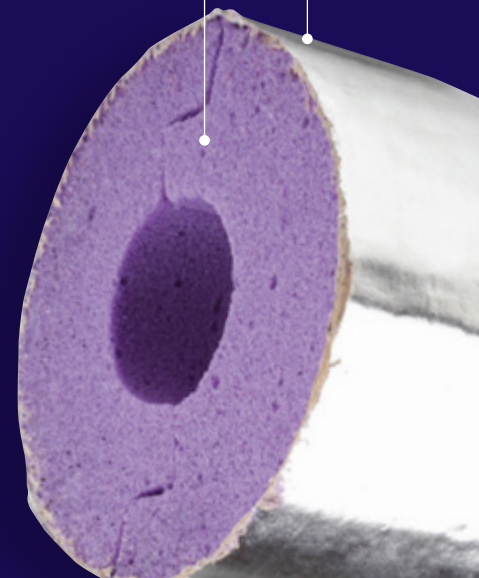



POLYBLOCK



25MM POLYBLOCK POLY FERRULE

PART N°	LENGTH (mm)	TO SUIT	OUTSIDE DIA (mm)	WALL THICKNESS (mm)	QTY
16FER-015-25-PB	45	15CU	64	25	10
16FER-020-25-PB	45	20CU	69	25	10
16FER-025-25-PB	45	25CU	76	25	10
16FER-032-25-PB	45	32CU	83	25	10
16FER-040-25-PB	45	40CU	89	25	10
16FER-050-25-PB	45	50CU	102	25	10
16FER-065-25-PB	45	65CU	114	25	10
16FER-080-25-PB	45	80CU	127	25	10
16FER-100-25-PB	45	100CU	152	25	10
16FER-125-25-PB	45	125CU	178	25	10
16FER-150-25-PB	45	150CU	203	25	10

THERMOLOC



19MM THERMOLOC POLY FERRULE

PART N°	LENGTH (mm)	TO SUIT	OUTSIDE DIA (mm)	WALL THICKNESS (mm)	QTY
16FER-006-19PLY	45	1/4CU	44	19	10
16FER-010-19PLY	45	3/8CU	48	19	10
16FER-012-19PLY	45	1/2CU	50	19	10
16FER-015-19PLY	45	5/8CU	52	19	10
16FER-020-19PLY	45	20CU	57	19	10
16FER-022-19PLY	45	7/8CU	60	19	10
16FER-028-19PLY	45	28CU	65	19	10
16FER-032-19PLY	45	32CU	69	19	10

25MM THERMOLOC POLY FERRULE

PART N°	LENGTH (mm)	TO SUIT	OUTSIDE DIA (mm)	WALL THICKNESS (mm)	QTY
16FER-006-25PLY	45	1/4CU	56	25	10
16FER-010-25PLY	45	3/8CU	60	25	10
16FER-012-25PLY	45	1/2CU	62	25	10
16FER-015-25PLY	45	5/8CU	65	25	10
16FER-020-25PLY	45	20CU	69	25	10
16FER-022-25PLY	45	7/8CU	72	25	10
16FER-025-25PLY	45	25CU	76	25	10
16FER-028-25PLY	45	28CU	79	25	10
16FER-032-25PLY	45	32CU	82	25	10
16FER-034-25PLY	45	34CU	86	25	10
16FER-035-25PLY	45	35CU	86	25	10
16FER-040-25PLY	45	40CU	89	25	10
16FER-042-25PLY	45	42CU	140	25	10
16FER-050-25PLY	45	50CU	102	25	10
16FER-054-25PLY	45	54CU	102	25	10
16FER-065-25PLY	45	65CU	114	25	10
16FER-080-25PLY	45	80CU	127	25	10
16FER-100-25PLY	45	100CU	152	25	10
16FER-125-25PLY	45	125CU	178	25	10



◆ Passive Fire





CONTENTS	PAGE
CAST-IN COLLARS	48
CAST-IN SHELLS	48
COMBAT COLLARS	48
PUDDLE FLANGE ASSEMBLIES	48
CAST-IN COLLAR EXTENSION TOP	48
RETROFIT COLLARS	49
GAS COLLARS	49
UNICOLLAR	49
PIPE FIRE WRAPS	49
FIRE WRAP	51
FIRE DAMPER PACKING	51
FIRE PILLOWS	51
FIRE BOXES	51
FIRE RATED BOARD	51
FIRE RATED INSULATION WRAP	51
FIRE SEALANTS	51





CAST-IN COLLARS

STACK CAST-IN COLLARS



HIGH STACK CAST-IN COLLAR			
PART N°	QF	TO SUIT	QTY
22CIC-H50S	B1118	40-50PVC	24
22CIC-H65S	B1120	40-65PVC	18
22CIC-H100S	B1111	65-100PVC	12
22CIC-H150S	B1115	150PVC	6
LOW STACK CAST-IN COLLAR			
PART N°	QF	TO SUIT	QTY
22CIC-L50-40S	B1125	40-50PVC	75
22CIC-L100S	B1123	100PVC	20
LOW STACK CAST-IN COLLAR REDUCERS			
PART N°	SIZE (mm)	TO SUIT	QTY
22CIC100-65RED	65-100	22CIC-L100S	75
22CIC100-80RED	80-100	22CIC-L100S	20

COMBAT COLLARS

COMBAT CAST-IN COLLARS



PART N°	QF	TO SUIT	QTY
22CLEAN40	B1107	40PVC	75
22CLEAN50	B1108	50PVC	75
22CLEAN100	B1106	100PVC	20

HIGH FLOOR WASTE CAST-IN COLLAR



PART N°	QF	TO SUIT	QTY
22CIC-H50FWS	B1117	40-50PVC	24
22CIC-H100FWS	B1109	65-100PVC	12
22CIC-H150FWS	B1114	150PVC	6

LOW FLOOR WASTE CAST-IN COLLAR



PART N°	QF	TO SUIT	QTY
22CIC-L80FWS	B1127	80PVC	24
22CIC-L100FWS	B1122	100PVC	20

PUDDLE FLANGE ASSEMBLIES

PUDDLE FLANGE FLOOR WASTE COLLAR



PART N°	QUICK	SIZE (mm)	TO SUIT	QTY
22FW100-PF160	B1192	160	100PVC	12
22FW100-PF180	B1193	180	100PVC	12

JUMBO CAST-IN COLLAR



PART N°	QF	TO SUIT	QTY
22CIC-250C	B1104	225PVC	1
22CIC-315C	B1105	300PVC	1

CAST-IN SHELLS

CAST-IN SHELLS



PART N°	QF	SIZE (mm)	QTY
22SH50	B1255	50	140
22SH100	B1253	100	63
22SH150	B1254	150	28

CAST-IN COLLAR EXTENSION TOP

CAST-IN COLLAR EXTENSION TOP



PART N°	QF	SIZE (mm)	QTY
22100TOP	B1089	100	80



RETROFIT COLLARS

RETROFIT COLLAR



PART N°	QF	TO SUIT	QTY
22RF-32R	B1234	16,20,25,32PEX/ 20,25 CONDUIT	50
22RF-50R	B1235	40PVC (w/socket), 50PVC/40,50,56HDPE	40
22RF-63R	B1236	50PVC (w/socket), 65PVC/50,56,63HDPE	36
22RF-65-80R	B1237	65,80PVC (w/socket), /63,75HDPE	18
22RF-110R	B1232	100PVC/110HDPE	20

FLOOR WASTE RETROFIT COLLAR



PART N°	QF	TO SUIT	QTY
22RF-LP50R	B1246	40,50PVC (w/socket) /50HDPE	15
22RF-LP65R	B1427	65 PVC (w/socket)	
22RF-LP80R	B1248	80PVC	12
22RF-LP100R	B1242	100PVC (w/socket)	20
22RF-LP100R-B	B1243	100PVC (w/socket)	18
22RF-LP100R-D	B1244	110HDPE	18
22RF-HP150R	B1239	150PVC (w/socket) /125,160HDPE	12

JUMBO RETROFIT COLLAR



PART N°	QF	TO SUIT	QTY
22RF-LP200R	B1245	200HDPE	1
22RF-HP250R	B1240	225PVC/250HDPE	1
22RF-HP315R	B1241	300PVC	1

GAS COLLARS

VELPEX GAS FIRE COLLAR



PART N°	QF	SIZE (mm)	QTY
22GAS32	B1201	16-32	20
22GAS50	B1202	40-50	5
22GAS63	B1203	63	1

UNICOLLAR

UNICOLLAR



PART N°	QF	TO SUIT	QTY
22UC	B1256	40-100PVC	8

PIPE FIRE WRAPS

PIPE FIRE WRAP



PART N°	QUICK	TO SUIT	QTY
22PW32	B1226	32PVC	10
22PW40	B1227	40PVC	10
22PW50	B1228	50PVC	10
22PW65	B1229	65PVC	10
22PW80	B1230	80PVC	10
22PW100F	B1223	100PVC	10
22PW100W	-	100PVC	10
22PW150	B1225	150PVC	5

WALL COLLAR BAND



PART N°	QUICK	LENGTH (mm)	TO SUIT	OUTSIDE DIAMETER (mm)	QTY
22BAND32	B1095	150	22PW32/40	54	10
22BAND50	B1096	150	22PW50	68	10
22BAND65	B1097	150	22PW65	87	10
22BAND80	B1098	150	22PW80	101	10
22BAND100	B1092	150	22PW100	132	10
22BAND150	B1093	150	22PW150	181	5



Applications

FyreWrap's core application is for fire rating metal ducts and duct systems, both single-layered and double-layered for either horizontal or vertical systems.

FyreWrap's aluminium foil with fiberglass-reinforced scrim which completely encapsulates the core provides additional handling strength, protection from tearing and most importantly total anti-bacterial resistance. Importantly, it also allows ease of identification of the FyreWrap in the field by building certifiers and engineers.

FyreWrap

FyreWrap is a foil-faced, fire protection wrap blanket designed to provide fire rating to ducts, kitchen exhausts, fan enclosures, penetration seals, critical services and structural steel elements.

Handling strength,
protection from tearing.

Highly engineered,
lightweight and
high temperature
thermal insulation
material-Insulfrax.



Lightweight -
up to 5 times
lighter than
traditional fire
spray

Clear identification
for fire certifying and
auditing purposes.

Greenguard listed for
microbial resistance.



FIRE WRAP

FYREWAP INSULATION



PART N°	QF	LENGTH (mm)	SIZE (mm)	QTY
22FWE18	B1198	7620	38 x 450	12
22FWE24	B1199	7620	38 x 610	12
22FWE48	B1197	7620	38x1220	6

FIRE DAMPER PACKING

FIRE DAMPER STRIP



PART N°	LENGTH (mm)	SIZE (mm)	QTY
22FDSR225	1000	225 x 20	1

FIRE PILLOWS

FIRE PILLOW



PART N°	QF	SIZE (mm)	QTY
22FPSP100	B1177	100 x 250 x 30	30
22FPMP200	B1176	200 x 250 x 40	20
22FPLP300	B1175	300 x 250 x 40	15

FIRE BOXES

FYREBOXES



* Other sizes available on request

PART N°	QF	WIDTH (mm)	QTY
22BFB150	B1099	150	2
22BFB300	B1100	300	1

MAXILITE FIRE RATED BOARD

MAXILITE FIRE RATED BOARD



PART N°	QF	SIZE (mm)	QTY
22MLB40	B1206	40 x 1520 x 1000	22
22MLB60	B1207	40 x 2040 x 1220	26

FIRE RATED INSULATION WRAP

BOSS P40-MAK WRAP



PART N°	SIZE (mm)	QTY
22P40MAK12	38 x 300 x 1000	1
22P40MAK45	38 x 300 x 4500	1

FIRE SEALANTS

*Please check suitability of application. Speak to our friendly staff today on 1300 750 750.

EXPANDING FOAM



PART N°	COLOUR	SIZE (ml)
22FPFOAM	White	750

FYRESET GROUT



PART N°	QF	SIZE (kg)
22FMG10	B1169	10

FIRE SOUND

* Refer page 166 for Sausage Guns



PART N°	COLOUR	SIZE
22FS300	GREY	450g
22FS600	GREY	600ml

FYREFLEX

* Refer page 166 for Sausage Guns



PART N°	COLOUR	SIZE
22FF300	GREY	450g
22FF600	GREY	600ml
22FF300W	WHITE	450g
22FF600W	WHITE	600ml

FIREMASTIC-HPE

* Refer page 166 for Sausage Guns



PART N°	COLOUR	SIZE (ml)
22FMHPE300	GREY	310
22FMHPE600	GREY	600



◆ Plumbing





Plumbing

CONTENTS	PAGE
SOUND LAGGING	55
THERMOBREAK LAGGING	57
SOLAR LAGGING	57
THERMOBREAK NO-CLAD LAGGING	59
NBR INSULATION	61
DRAIN LAGGING	62
PLUMBING CONSUMABLES	62
PIPE SEALANTS	63
PIPE MARKERS	64
COPPER PRESS FITTINGS	67
COPPER PRESS XL FITTINGS	73
COPPER TUBE	76
COPPER TUBE - REFRIGERATION R410A	76
WELD FITTINGS	77



Acura Sound Lagging

Acura Sound Lagging has an exceedingly dense mass layer providing maximum performance to ensure significant noise reduction, defined high sound absorption and excellent acoustic performance combined with a compacted fire resistant covering, supplied pre-cut so you simply wrap & tape.

**Acura Sound Lagging is unique,
just wrap and tape, job done.**

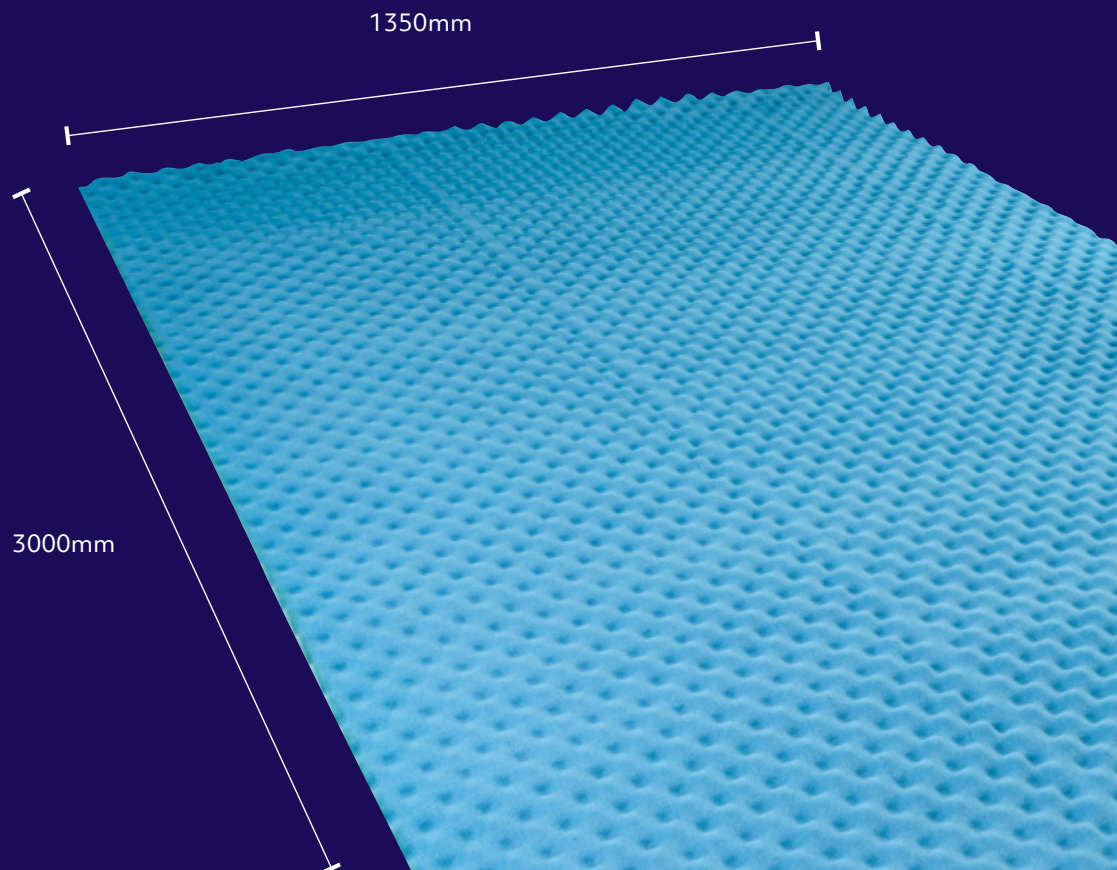

Features

- Green Star Rated ASTM D5116-17
- Odour free
- Light weight product
- Contains no ozone depleting substances
- Fire Tested to AS 1530.3 with excellent flame resistance
- Independent Acoustic Test Report 6625-1.3R
- Complies with Building Code of Australia (BCA)
- Pre-cut for effortless installation



SOUND LAGGING

SOUND LAGGING

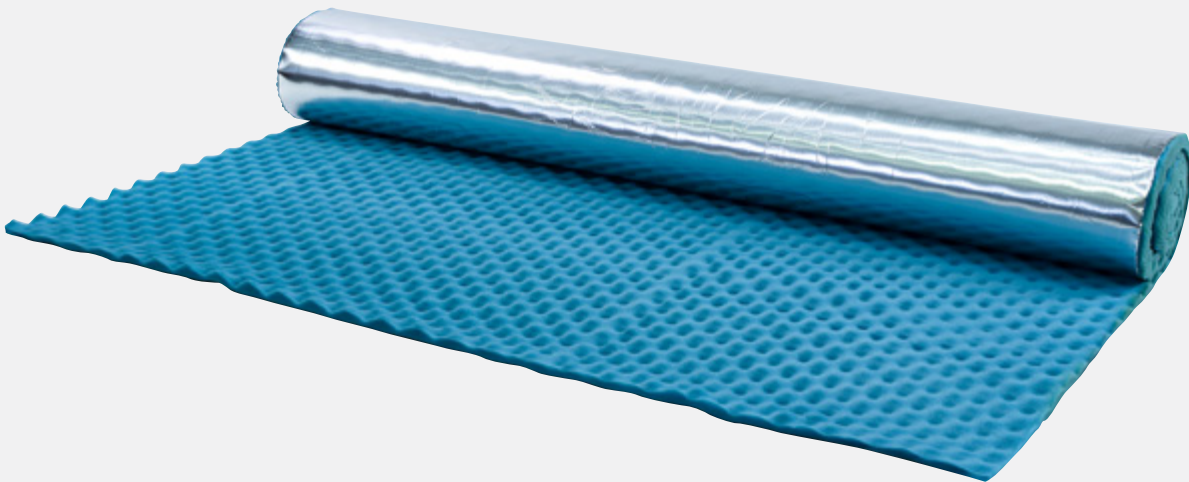

* Refer page 129 for Aluminium Tape.

PART N°	SIZE (mm)	LENGTH (mm)	WEIGHT (kg/m2)	TO SUIT	QTY
21SL4525C	1350	5000	5	-	30
21SL4525C-3	1350	3000	5	-	30

INSERTION LOSS (DB) OF SOUND LAGGING

A- Weighted Insertion Loss of Bare Pipe versus pipe lagged with SOUNDLAG 8025

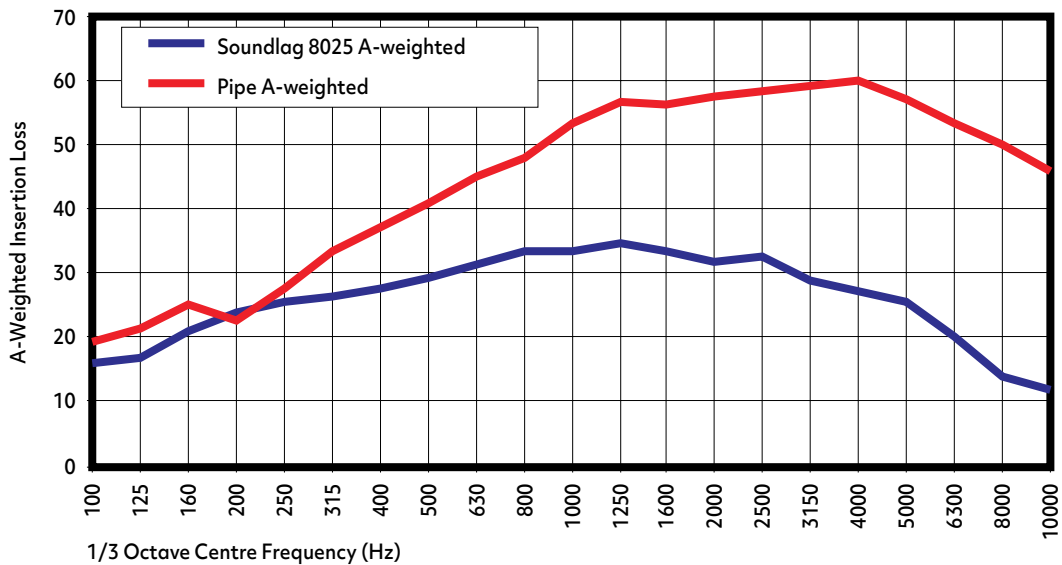



◆ Acura Thermobreak Lagging

Acura Thermobreak Lagging is a closed cell, physically crosslinked polyolefin foam with a density of 25 kg/m³, faced with heat laminated pure aluminium foil with reinforcement.

Premium performance pipe insulation offering lower installation costs and maximum energy savings.

◆ Features

- Completely closed cell, physically crosslinked foam pipe insulation
- Heat-bonded factory applied reinforced aluminium foil
- Pre-slit for faster installation
- Flexible, tough and durable
- Excellent compression resistance due to its cross linked foam structure
- Superior insulating properties compared to other flexible closed cell foams
- Chlorine free - suitable for use with stainless steel pipe
- Very high vapour diffusion resistance, Class 1 vapour retarder under ASH RAE 2009
- No cladding required for internal applications
- Conforms to ISO 5659-2 "Smoke Density & Toxicity".
- Anti-Microbial
- Green star compliant product (VOC)
- Complies to NFPA 90A & NFPA 90B

Very high vapour diffusion resistance

Reinforced Aluminium Foil

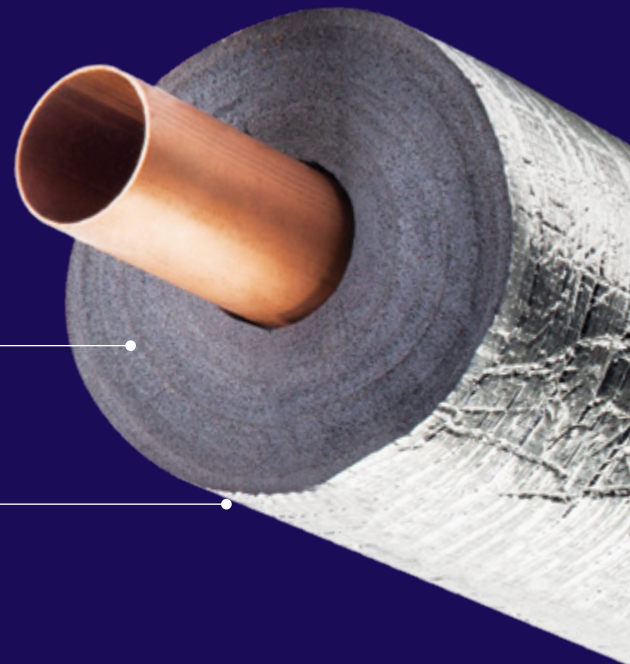



THERMOBREAK LAGGING

THERMOBREAK LAGGING



* Refer page 129 for Aluminium Tape.

THERMOBREAK LAGGING - 25MM

PART N°	LENGTH (mm)	I.D. (mm)	TO SUIT	WALL THICKNESS (mm)	QTY
41HCL1225	2000	13	15CU	25	40
41HCL1525	2000	16	16PEX	25	38
41HCL2025	2000	20	20CU	25	35
41HCL2525	2000	25	25CU	25	30
41HCL3225	2000	32	32CU	25	28
41HCL4025	2000	38	40CU	25	25
41HCL4225	2000	42	42CU	25	-
41HCL5025	2000	51	50CU	25	17
41HCL5425	2000	54	54CU	25	-
41HCL6025	2000	60	60CU	25	-
41HCL6525	2000	64	65CU	25	14
41HCL8025	2000	76	80CU	25	10
41HCL10025	2000	102	100CU	25	9
41HCL12525	2000	127	125CU	25	8
41HCL15025	2000	152	150CU	25	5

THERMOBREAK LAGGING - 38MM

PART N°	LENGTH (mm)	I.D. (mm)	TO SUIT	WALL THICKNESS (mm)	QTY
41HCL2038	2000	20	20CU	38	20
41HCL2538	2000	25	25CU	38	20
41HCL3238	2000	32	32CU	38	15
41HCL4038	2000	38	40CU	38	15
41HCL5038	2000	51	50CU	38	12
41HCL6538	2000	64	65CU	38	10
41HCL8038	2000	76	80CU	38	8
41HCL10038	2000	102	100CU	38	5
41HCL12538	2000	127	125CU	38	5
41HCL15038	2000	152	150CU	38	4

Other sizes available on request.

Premium performance thermal pipe insulation with a very high vapour diffusion resistance. Completely closed cell, physically crosslinked polyolefin foam with a density of 25 kg/m³, faced with heat laminated pure aluminium foil with reinforcement for steel, plastic and copper pipes. Pre-slit for faster installation.

Acura Thermobreak lagging is a preformed closed cell physically crosslinked polyolefin foam tube insulation with reinforced foil facing for steel, plastic and copper pipes.

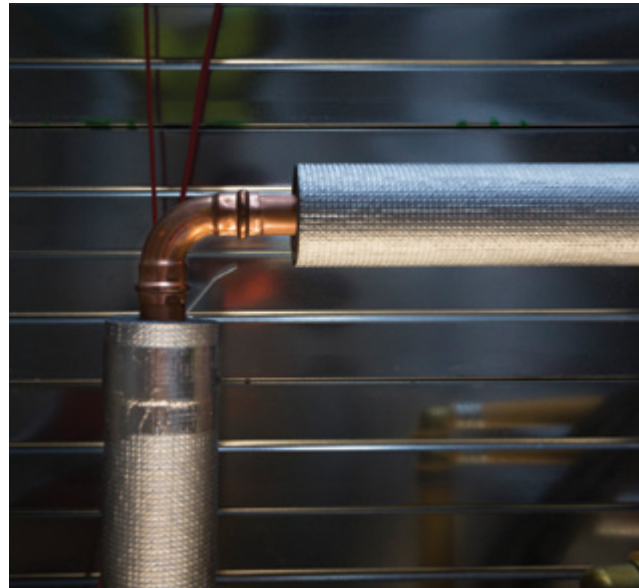

SOLAR LAGGING

SOLAR LAGGING



PART N°	LENGTH (mm)	I.D. (mm)	TO SUIT	WALL THICKNESS (mm)	QTY
41HCL2025SOLAR	2000	20	20CU	25	60
41HCL2525SOLAR	2000	25	25CU	25	60
41HCL3225SOLAR	2000	32	32CU	25	60
41HCL4025SOLAR	2000	38	40CU	25	60



◆ Acura Thermobreak No-Clad

Acura Thermobreak No-Clad is physically (irradiation) crosslinked closed cell polyolefin foam with factory applied, heavy duty multilayer composite with a specially developed UV and weather durable coating.

Designed as a cost effective alternative to cladding of pipe and duct insulation to prevent mechanical damage.

◆ Features

- Puncture resistant multilayer aluminium foil.
- A salt-water resistant, UV and weather durable coating.
- The aluminium foil is reinforced with an ultra tough, close weave scrim.
- The flexible closed cell physically cross-linked polyolefin foam underneath allows for distribution of impact force so inhibiting mechanical damage to the insulation.
- Excellent compression resistance due to its cross-linked foam structure.
- Superior insulating properties compared to other flexible closed cell foams.
- Anti-Microbial.
- Although designed to be resistant to mechanical damage, Foilflex II No-Clad has been designed for easy fabrication using sharp knives.

Puncture resistant
multilayer aluminium foil

UV and weather durable
coating

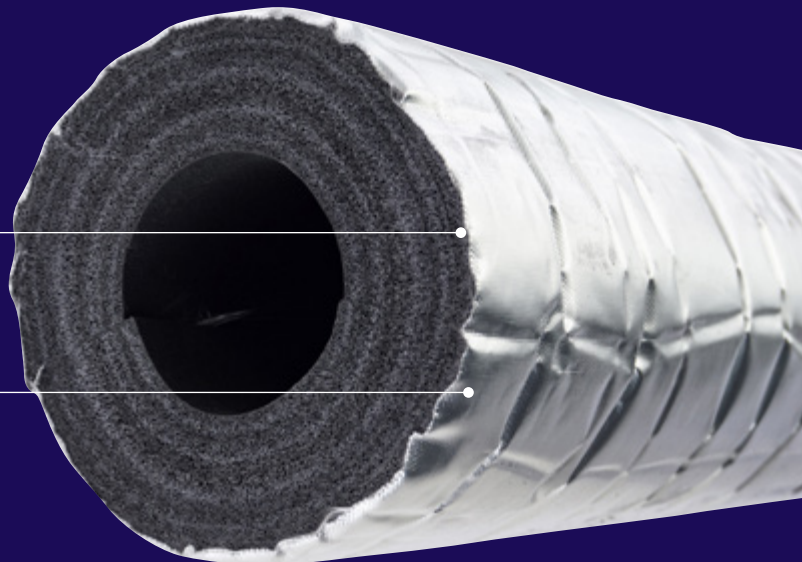



THERMOBREAK NO-CLAD LAGGING

THERMOBREAK NO-CLAD LAGGING



THERMOBREAK NO-CLAD LAGGING - 25MM

PART N°	LENGTH (mm)	TO SUIT	WALL THICKNESS (mm)	QTY
41HCL1525TCLAD	2000	15CU	25	60
41HCL2025TCLAD	2000	20CU	25	50
41HCL2525TCLAD	2000	25CU	25	40
41HCL3225TCLAD	2000	32CU	25	35
41HCL4025TCLAD	2000	40CU	25	30
41HCL5025TCLAD	2000	50CU	25	25
41HCL6525TCLAD	2000	65CU	25	20
41HCL8025TCLAD	2000	80CU	25	15
41HCL10025TCLAD	2000	100CU	25	10
41HCL12525TCLAD	2000	125CU	25	7
41HCL15025TCLAD	2000	150CU	25	6
41HCL20025TCLAD	2000	200CU	25	1

THERMOBREAK NO-CLAD LAGGING - 50MM

PART N°	LENGTH (mm)	TO SUIT	WALL THICKNESS (mm)	QTY
41HCL2050TCLAD	2000	20CU	50	20
41HCL2550TCLAD	2000	25CU	50	15
41HCL3250TCLAD	2000	32CU	50	15
41HCL4050TCLAD	2000	40CU	50	12
41HCL5050TCLAD	2000	50CU	50	12
41HCL6550TCLAD	2000	65CU	50	10
41HCL8050TCLAD	2000	80CU	50	10
41HCL10050TCLAD	2000	100CU	50	6
41HCL12550TCLAD	2000	125CU	50	4
41HCL15050TCLAD	2000	150CU	50	4
41HCL20050TCLAD	2000	200CU	50	1

HEAVY DUTY FOIL FACED NO-CLAD TAPE



* Refer page 129 for Aluminium Tape.

PART N°	LENGTH (m)	SIZE (mm)	QTY
21AT50TCLAD	50	50	1
21AT72TCLAD	50	75	1



Acura NBR Insulation

NBR insulation pipe installation is a flexible closed cell thermal insulation material for condensation control in air-conditioning, refrigeration and chilled water installations.

It is also suitable for reducing thermal losses in heating and plumbing systems. The combination of its technical properties (a low thermal conductivity and a high resistance to water vapour transmission) and its competitive price makes it a cost effective energy-saving solution.

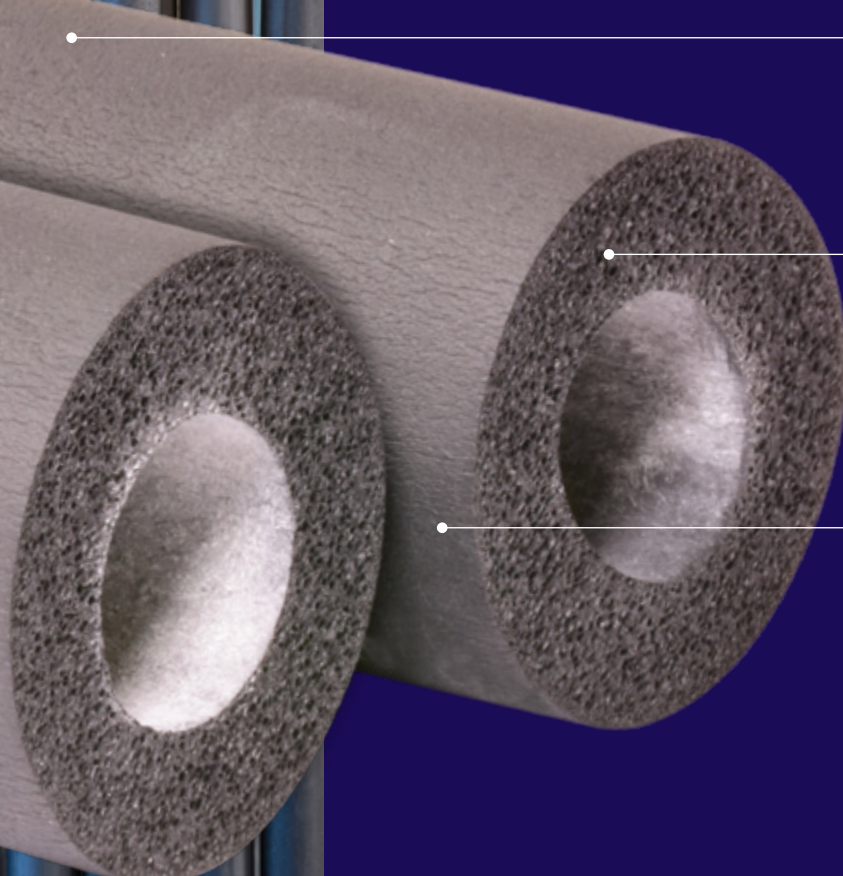

Outstanding thermal performance

Very secure joints when the sound lagging glue is used

Built-in water vapour barrier



NBR INSULATION

NBR INSULATION



Refer page 129 for Adhesive.

NBR a flexible closed cell elastomeric foam suitable for condensation control, thermal insulation and sound absorption. The NBR range covers the majority of pipe sizes used in every possible installation.

NBR is rated AS 1530.3 for spread of flame and fire propagation. It does not melt, nor drip when burning, therefore does not cause fire transfer. Low smoke density makes it a safer option.

Quick and easy to install due to its high flexibility, dimensional stability and smooth surface skin. It can be applied on pipes, ducts and tanks.

NBR pipe insulation is compounded to achieve a high water vapour diffusion resistance through its closed cell structure and outer dense skin. This helps maintaining a steady thermal performance and a long service life.

Material strength is approximately twice as strong as other elastomerics, an elastomeric foam based on synthetic rubber with density between 60-70 Kg/m³.

NBR INSULATION - 13MM

PART N°	LENGTH (mm)	TO SUIT (inch)	TO SUIT (mm)	WALL THICKNESS (mm)	QTY
41ALB0613	2000	1/4	6	13	60
41ALB0913	2000	3/8	10	13	50
41ALB1213	2000	1/2	12	13	45
41ALB1513	2000	5/8	15	13	30
41ALB2013	2000	3/4	20	13	30
41ALB2513	2000	1	25	13	20
41ALB2813	2000	1 1/8	28	13	25
41ALB3213	2000	1 1/4 - 32CU	32	13	15
41ALB4013	2000	1 1/2 - 40CU	38	13	15
41ALB5013	2000	2 - 50CU	50	13	15
41ALB6513	2000	2 1/2 - 65CU	63.5	13	15

NBR INSULATION - 19MM

PART N°	LENGTH (mm)	TO SUIT	TO SUIT (mm)	WALL THICKNESS (mm)	QTY
41ALB0619	2000	1/4	6	19	30
41ALB0919	2000	3/8	10	19	30
41ALB1219	2000	1/2	12	19	30
41ALB1519	2000	5/8	15	19	20
41ALB2019	2000	3/4	20	19	20
41ALB2219	2000	7/8	22	19	17
41ALB2519	2000	1	25	19	12
41ALB2819	2000	1 1/8	28	19	9
41ALB3219	2000	1 1/4 - 32CU	32	19	9
41ALB3519	2000	1 3/8	35	19	9
41ALB4019	2000	1 1/2 - 40CU	38	19	9
41ALB5019	2000	2 - 50CU	50	19	9
41ALB5419	2000	2 1/8	54	19	8

NBR INSULATION - 25MM

PART N°	LENGTH (mm)	TO SUIT (inch)	TO SUIT (mm)	WALL THICKNESS (mm)	QTY
41ALB0925	2000	3/8	10	25	20
41ALB1225	2000	1/2	12	25	20
41ALB1525	2000	5/8	15	25	15
41ALB2025	2000	3/4	20	25	12
41ALB2225	2000	7/8	22	25	12
41ALB2525	2000	1	25	25	9
41ALB2825	2000	1 1/8	28	25	8
41ALB3525	2000	1 3/8	35	25	8

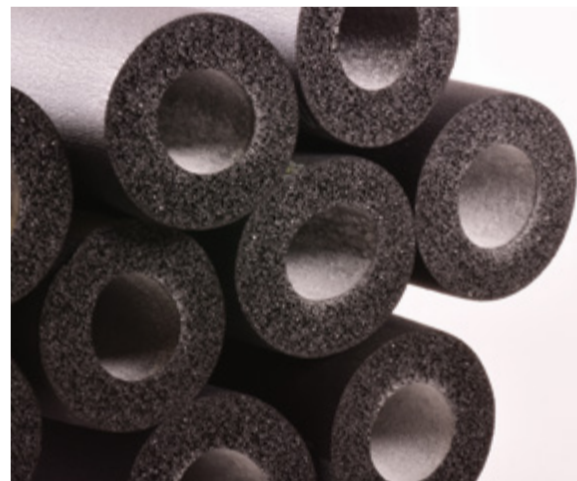

32mm also available on request.



DRAIN LAGGING

PLUMBING LAGGING



PART N°	SIZE (mm)	LENGTH (mtr)	QTY
21PL3270J	100	25	10

POLILAG



PART N°	SIZE (mm)	LENGTH (mtr)	QTY
16POLYLAG	100	10	10

POLY SLEEVE



PART N°	TO SUIT	LENGTH (mtr)	QTY
16POLYSLV043	40PVC	2	1
16POLYSLV054	50PVC	2	1
16POLYSLV069	65PVC	2	1
16POLYSLV110	100PVC	2	1
16POLYSLV170	150PVC	2	1

PLUMBING CONSUMABLES

AQUASEAL



PART N°	QF	SIZE (mm)	MATERIAL SIZE (mm)	QTY
31AFE0B	C1145	3 - 20	75 x 75	20
31AFE1B	C1146	5 - 45	115 x 115	20
31AFE2B	C1147	25 - 70	155 x 155	20
31AFE3B	C1148	50 - 100	205 x 205	10
31AFE4B	C1149	90 - 150	255 x 255	10
31AFE5B	C1150	125 - 200	305 x 305	10
31AFE6B	C1151	150 - 230	355 x 355	10
31AFE7B	C1152	200 - 300	440 x 440	5

DENSO TAPE



PART N°	QF	SIZE (mm)	QTY
21DENSO50	C1119	50	36
21DENSO100	C1118	100	18

FEMALE TEST CAP



PART N°	QF	QTY
40TC12F	C1597	100

PLASTIC STUD GROMMET



* Refer page 142 for Stud Punch.

PART N°	QF	HOLE SIZE (mm)	QTY
26ESGP	10834	34	100

METAL NOGGING



PART N°	QF	QTY
30BARNOG	C1120	24

TRIMMER



PART N°	SIZE (mm)	QTY
30TRIMMER	2400 x 95 x 17	1

KEY TAG



PART N°	QF	COLOUR	QTY
30KEYTAG	I1212	WHITE	50
30KEYTAG-B	I1213	BLUE	50
30KEYTAG-L	I1214	LILAC	50
30KEYTAG-R	I1215	RED	50



PIPE SEALANTS

PVC PIPE CEMENT - BLUE



PART N°	QF	SIZE	QTY
30PVCB	C1128	500ml	24
30PVCB-4L	C1129	4L	4

PVC PIPE CEMENT - CLEAR



PART N°	QF	SIZE	QTY
30PVCC	C1130	500ml	24
30PVCC-4L	C1131	4L	4

PVC PIPE CEMENT - GREEN



PART N°	QF	SIZE	QTY
30PVCG	C1133	500ml	24

PVC PRIMER FLUID - RED



PART N°	QF	SIZE	QTY
30PVCP-R	C1137	500ml	24
30PVCP-R-4L	C1138	4L	4

PVC PRIMER FLUID - CLEAR



PART N°	QF	SIZE	QTY
30PVCP-C	C1135	500ml	24
30PVCP-C-4L	C1136	4L	4

MOLYKOTE ANTI SEIZE PASTE



PART N°	QF	SIZE	QTY
30ASPASTE	-	500g	1

LOXEAL



PART N°	QF	SIZE	QTY
30LOXEAL5811-100	C1123	100ML	10
30LOXEAL-250	C1124	250ML	10

MIRROR PASTE



PART N°	QF	QTY
30MPASTE	I1224	1

HAWKINS PASTE



PART N°	QF	QTY
30HPASTE	C1122	1

LOCTITE STRING SEAL



PART N°	QF	QTY
30LT55	C1125	1

TEFLON TAPE



PART N°	QF	COLOUR	QTY
30TEFP	C1141	PINK	10
30TEFW	C1142	WHITE	10
30TEFY	C1143	YELLOW	10
30TEFG	C1140	GREY	10



PIPE MARKERS

PIPE MARKERS



* Please Note: Packs of 10

CUSTOM PIPE MARKERS

PART N°	QF	DESCRIPTION	LENGTH (mm)	SIZE (mm)	QTY
3216830	C1289	<CUSTOM TEXT>	380	30	1
3216850	C1290	<CUSTOM TEXT>	400	50	1

STANDARD PIPE MARKERS

PART N°	QF	DESCRIPTION	LENGTH (mm)	SIZE (mm)	QTY
3210030	C1155	SOLAR HOT WATER RETURN	380	30	1
3210050	C1156	SOLAR HOT WATER RETURN	400	50	1
3210130	C1157	CHILLED WATER	380	30	1
3210150	C1158	CHILLED WATER	400	50	1
3210230	C1159	SYPHONIC STORMWATER	380	30	1
3210250	C1160	SYPHONIC STORMWATER	400	50	1
3210330	C1161	COLD WATER	380	30	1
3210350	C1162	COLD WATER	400	50	1
3210430	C1163	CHILLED WATER RETURN	380	30	1
3210450	C1164	CHILLED WATER RETURN	400	50	1
3210630	C1167	DOMESTIC HOT WATER	380	30	1
3210650	C1168	DOMESTIC HOT WATER	400	50	1
3210730	C1169	REVERSE OSMOSIS	380	30	1
3210750	C1170	DOMESTIC WATER	400	50	1
3210830	C1171	STORMWATER DRAINAGE	380	30	1
3210850	C1172	STORMWATER DRAINAGE	400	50	1
3210930	C1173	DRINKING WATER	380	30	1
3210950	C1174	FLOW	400	50	1
3211130	C1175	RECLAIMED WATER	380	30	1
3211150	C1176	HEATING WATER RETURN	400	50	1
3211230	C1177	SOFT WATER	380	30	1
3211250	C1178	HEATING WATER FLOW	400	50	1
3211330	C1179	SOLAR HOT WATER FLOW	380	30	1
3211350	C1180	SOLAR HOT WATER FLOW	400	50	1
3211430	C1181	HOT WATER	380	30	1
3211450	C1182	HOT WATER	400	50	1
3211530	C1183	NON-POTABLE WATER	380	30	1
3211550	C1184	NON-POTABLE WATER	400	50	1
3211630	C1185	OVERFLOW	380	30	1
3211650	C1186	TANK OVERFLOW	400	50	1
3211730	C1187	POTABLE WATER	380	30	1
3211750	C1188	POTABLE WATER	400	50	1
3211830	C1189	TREATED WATER	380	30	1
3211850	C1190	RAINWATER	400	50	1
3211930	C1191	WASTE WATER	380	30	1

PART N°	QF	DESCRIPTION	LENGTH (mm)	SIZE (mm)	QTY
3211950	C1192	WASTE WATER	400	50	1
3213630	C1225	NATURAL GAS KPA	380	30	1
3213650	C1226	NATURAL GAS KPA	400	50	1
3214830	C1249	FIRE HOSE REEL	380	30	1
3214850	C1250	FIRE HOSE REEL	400	50	1
3214930	C1251	FIRE HYDRANT	380	30	1
3214950	C1252	SEWER PUMP LINE	400	50	1
3215030	C1253	FIRE SERVICE	380	30	1
3215050	C1254	FIRE SERVICE	400	50	1
3215130	C1255	FIRE SPRINKLER	380	30	1
3215150	C1256	FIRE SPRINKLERS	400	50	1
3215730	C1267	SOIL WASTE	380	30	1
3215750	C1268	GREASY WASTE	400	50	1
3215930	C1271	SEWERAGE	380	30	1
3215950	C1272	SEWERAGE	400	50	1
3216030	C1273	WASTE	380	30	1
3216050	C1274	WASTE	400	50	1
3216130	C1275	VENT	380	30	1
3216150	C1276	VENT	400	50	1
3216230	C1277	STORM WATER	380	30	1
3216250	C1278	STORM WATER	400	50	1
3216330	C1279	HOT WATER FLOW	380	30	1
3216350	C1280	HOT WATER FLOW	400	50	1
3216430	C1281	COLD WATER FLOW	380	30	1
3216450	C1282	COLD WATER FLOW	400	50	1
3216530	C1283	HOT WATER RETURN	380	30	1
3216550	C1284	HOT WATER RETURN	400	50	1
3216630	C1285	COLD WATER RETURN	380	30	1
3216650	C1286	COLD WATER RETURN	400	50	1
3216730	C1287	DOMESTIC COLD WATER	380	30	1
3216750	C1288	DOMESTIC COLD WATER	400	50	1
3216930	C1291	RECLAIMED WATER - DO NOT DRINK	380	30	1
3217030	C1292	CONDENSATE	380	30	1
3217050	C1293	STEAM RETURN	400	50	1

TIGER TAPE



PART N°	QF	SIZE (mm)	LENGTH (mtr)	QTY
32TT50	C1309	48	33	1



siFramo Modular Steelwork Solutions

siFramo is a multi-functional, non-welded support system for the modular construction of framing solutions.

This amazing product simply screws together, eliminating the need of drilling, bolting and welding, effectively preventing on-site delays through its pregalvanised finish.

Features

- Non-welded modular steelwork
- Higher performance / lower weight of steel
- Maximum flexibility, minimum installation time
- Easy to assemble and disassemble
- Compatible with other installation systems
- High corrosion resistance as standard
- One thread forming screw for all component connections
- Frame and module assembly modifications can be made quickly on site with no loss of time, cut-outs or re-works

siFramo has revolutionised support structures for services by providing the first real alternative to welding structural framework for supporting weights beyond capacity of strut.

Parts are reusable

Multiple applications

*Conditions apply.

See page 18 for our Sikla product range.

*Free design service.

Seismic rating available to make sure your project is **compliant**.





ACURA PRESS

The Copper Press Press Fit Connection System is fully certified, reliable and simple to use, secure with permanent joints, practical design, leak indicator and flame free installation.

Guaranteed lifelong secure leak-proof joints. Copper Press is versatile, cost effective and safe. The Copper Press joints can't be tampered with and the design ensures easy access. Fully certified, totally on-site practical with timeless performance. With a simple installation method and no brazing, it only takes seconds to create a permanent joint between pipe and fitting.

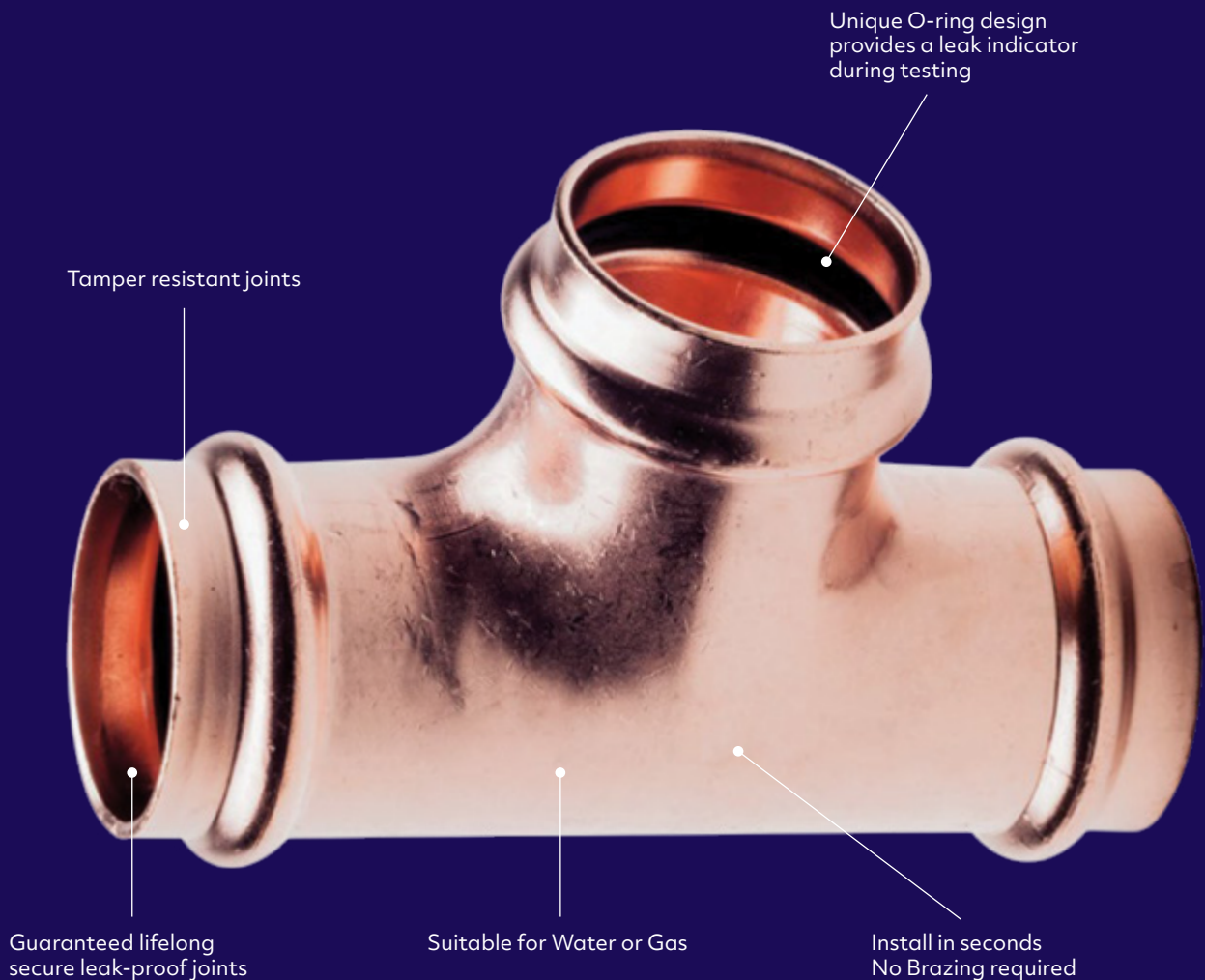



ACURA PRESS

Our copper press range consists of fittings sized 15-50mm.

Acura copper press-fit connection system is always cost effective in material, time and labour. It offers a simple installation method that does not require brazing.

The copper press superior resistance reduction technology allows water or gas to flow smoothly throughout the total pipeline system.

Significantly improves the pipe and flow performance as well as the efficiencies created through the installation method. Copper press is cost effective and also minimises material, time & labour.



PLUMBING

COPPER PRESS FITTINGS

COPPER PRESS ELBOW 45DEG

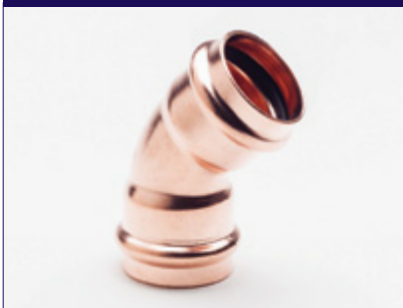

COPPER PRESS WATER ELBOW 45 DEG

PART N°	QF	SIZE (mm)	QTY
49VPW45E15	C2635	15	10
49VPW45E20	C2636	20	10
49VPW45E25	C2637	25	5
49VPW45E32	C2638	32	5
49VPW45E40	C2639	40	1
49VPW45E50	C2640	50	1

COPPER PRESS GAS ELBOW 45 DEG

PART N°	QF	SIZE (mm)	QTY
49VPG45E15	C2496	15	10
49VPG45E20	C2497	20	10
49VPG45E25	C2498	25	5
49VPG45E32	C2499	32	5
49VPG45E40	C2500	40	1
49VPG45E50	C2501	50	1

COPPER PRESS ELBOW 90DEG

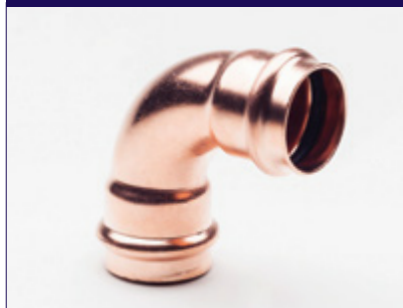

COPPER PRESS WATER ELBOW 90 DEG

PART N°	QF	SIZE (mm)	QTY
49VPW90E15	C2646	15	10
49VPW90E20	C2647	20	10
49VPW90E25	C2648	25	5
49VPW90E32	C2649	32	5
49VPW90E40	C2650	40	1
49VPW90E50	C2651	50	1

COPPER PRESS GAS ELBOW 90 DEG

PART N°	QF	SIZE (mm)	QTY
49VPG90E15	C2505	15	10
49VPG90E20	C2506	20	10
49VPG90E25	C2507	25	5
49VPG90E32	C2508	32	5
49VPG90E40	C2509	40	1
49VPG90E50	C2510	50	1

COPPER PRESS END CAP

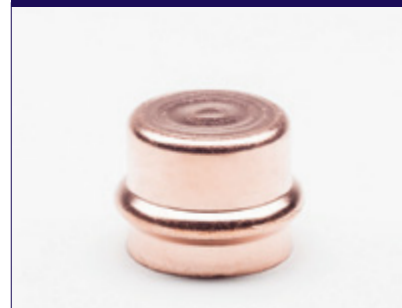

COPPER PRESS WATER END CAP

PART N°	QF	SIZE (mm)	QTY
49VPWEC15	C2698	15	10
49VPWEC20	C2699	20	10
49VPWEC25	C2700	25	5
49VPWEC32	C2701	32	5
49VPWEC40	C2702	40	1
49VPWEC50	C2703	50	1

COPPER PRESS GAS END CAP

PART N°	QF	SIZE (mm)	QTY
49VPGEC15	C2536	15	10
49VPGEC20	C2537	20	10
49VPGEC25	C2538	25	5
49VPGEC32	C2539	32	2
49VPGEC40	C2540	40	1
49VPGEC50	C2541	50	1



COPPER PRESS FITTING REDUCER



COPPER PRESS WATER FITTING REDUCER

PART N°	QF	SIZE (mm)	QTY
49VPWRCMF2015	C2711	20 x 15	10
49VPWRCMF2515	C2712	25 x 15	5
49VPWRCMF2520	C2713	25 x 20	5
49VPWRCMF3220	C2714	32 x 20	5
49VPWRCMF3225	C2715	32 x 25	5
49VPWRCMF4020	C2716	40 x 20	1
49VPWRCMF4025	C2717	40 x 25	1
49VPWRCMF4032	C2718	40 x 32	1
49VPWRCMF5025	C2719	50 x 25	1
49VPWRCMF5032	C2720	50 x 32	1
49VPWRCMF5040	C2721	50 x 40	1

COPPER PRESS GAS FITTING REDUCER

PART N°	QF	SIZE (mm)	QTY
49VPGRCMF2015	C2542	20 x 15	10
49VPGRCMF2515	C2543	25 x 15	5
49VPGRCMF2520	C2544	25 x 20	5
49VPGRCMF3220	C2545	32 x 20	5
49VPGRCMF3225	C2546	32 x 25	5
49VPGRCMF4020	C2547	40 x 20	1
49VPGRCMF4025	C2548	40 x 25	1
49VPGRCMF4032	C2549	40 x 32	1
49VPGRCMF5025	C2550	50 x 25	1
49VPGRCMF5032	C2551	50 x 32	1
49VPGRCMF5040	C2552	50 x 40	1

COPPER PRESS SLIP COUPLING



COPPER PRESS WATER SLIP COUPLING

PART N°	QF	SIZE (mm)	QTY
49VPWSLP15	C2769	15	10
49VPWSLP20	C2770	20	10
49VPWSLP25	C2771	25	5
49VPWSLP32	C2772	32	5
49VPWSLP40	C2773	40	1
49VPWSLP50	C2774	50	1

COPPER PRESS EQUAL TEE



COPPER PRESS WATER EQUAL TEE

PART N°	QF	SIZE (mm)	QTY
49VPWT15	C2778	15	10
49VPWT20	C2779	20	10
49VPWT25	C2780	25	5
49VPWT32	C2781	32	5
49VPWT40	C2782	40	1
49VPWT50	C2783	50	1

COPPER PRESS GAS EQUAL TEE

PART N°	QF	SIZE (mm)	QTY
49VPGT15	C2600	15	10
49VPGT20	C2601	20	10
49VPGT25	C2602	25	5
49VPGT32	C2603	32	5
49VPGT40	C2604	40	1
49VPGT50	C2605	50	1

COPPER PRESS STRAIGHT COUPLING



COPPER PRESS WATER STRAIGHT COUPLING

PART N°	QF	SIZE (mm)	QTY
49VPWSC15	C2760	15	10
49VPWSC20	C2761	20	10
49VPWSC25	C2762	25	5
49VPWSC32	C2763	32	5
49VPWSC40	C2764	40	1
49VPWSC50	C2765	50	1

COPPER PRESS GAS STRAIGHT COUPLING

PART N°	QF	SIZE (mm)	QTY
49VPGSC15	C2591	15	10
49VPGSC20	C2592	20	10
49VPGSC25	C2593	25	5
49VPGSC32	C2594	32	5
49VPGSC40	C2595	40	1
49VPGSC50	C2596	50	1



COPPER PRESS REDUCING COUPLING



COPPER PRESS WATER REDUCING COUPLING

PART N°	QF	SIZE (mm)	QTY
49VPWRC2015	C2738	20 x 15	10
49VPWRC2515	C2739	25 x 15	10
49VPWRC2520	C2740	25 x 20	5
49VPWRC3215	C2741	32 x 15	5
49VPWRC3220	C2742	32 x 20	5
49VPWRC3225	C2743	32 x 25	5
49VPWRC4020	C2744	40 x 20	5
49VPWRC4025	C2745	40 x 25	1
49VPWRC4032	C2746	40 x 32	1
49VPWRC5020	C2747	50 x 20	1
49VPWRC5025	C2748	50 x 25	1
49VPWRC5032	C2749	50 x 32	1
49VPWRC5040	C2750	50 x 40	1

COPPER PRESS GAS REDUCING COUPLING

PART N°	QF	SIZE (mm)	QTY
49VPGRC2015	C2569	20 x 15	10
49VPGRC2515	C2570	25 x 15	10
49VPGRC2520	C2571	25 x 20	5
49VPGRC3215	C2572	32 x 15	5
49VPGRC3220	C2573	32 x 20	5
49VPGRC3225	C2574	32 x 25	5
49VPGRC4020	C2575	40 x 20	5
49VPGRC4025	C2576	40 x 25	1
49VPGRC4032	C2577	40 x 32	1
49VPGRC5020	C2578	50 x 20	1
49VPGRC5025	C2579	50 x 25	1
49VPGRC5032	C2580	50 x 32	1
49VPGRC5040	C2581	50 x 40	1

COPPER PRESS BRASS SUPPORT RING



COPPER PRESS WATER BRASS SUPPORT RING

PART N°	QF	SIZE (mm)	QTY
49VPBSC50	C2495	50	10

COPPER PRESS UNEQUAL TEE



COPPER PRESS WATER UNEQUAL TEE

PART N°	QF	SIZE (mm)	QTY
49VPWTR201515	C2787	20 x 15(c) x 15	10
49VPWTR201520	C2788	20 x 15(c) x 20	10
49VPWTR202015	C2789	20 x 20(c) x 15	10
49VPWTR251525	C2790	25 x 15(c) x 25	5
49VPWTR252025	C2791	25 x 20(c) x 25	5
49VPWTR321532	C2792	32 x 15(c) x 32	5
49VPWTR322032	C2793	32 x 20(c) x 32	5
49VPWTR322532	C2794	32 x 25(c) x 32	5
49VPWTR402040	C2795	40 x 20(c) x 40	1
49VPWTR402540	C2796	40 x 25(c) x 40	1
49VPWTR403240	C2797	40 x 32(c) x 40	1
49VPWTR502050	C2798	50 x 20(c) x 50	1
49VPWTR502550	C2799	50 x 25(c) x 50	1
49VPWTR503250	C2800	50 x 32(c) x 50	1
49VPWTR504050	C2801	50 x 40(c) x 50	1

COPPER PRESS GAS UNEQUAL TEE

PART N°	QF	SIZE (mm)	QTY
49VPGTR2015	C2610	20 x 15(c) x 20	10
49VPGTR2020	C2611	20 x 20(c) x 15	10
49VPGTR2515	C2612	25 x 15(c) x 25	5
49VPGTR2520	C2613	25 x 20(c) x 25	5
49VPGTR3215	C2614	32 x 15(c) x 32	5
49VPGTR3220	C2615	32 x 20(c) x 32	5
49VPGTR3225	C2616	32 x 25(c) x 32	5
49VPGTR4020	C2617	40 x 20(c) x 40	1
49VPGTR4025	C2618	40 x 25(c) x 40	1
49VPGTR4032	C2619	40 x 32(c) x 40	1
49VPGTR5020	C2621	50 x 20(c) x 50	1
49VPGTR5025	C2622	50 x 25(c) x 50	1
49VPGTR5032	C2623	50 x 32(c) x 50	1
49VPGTR5040	C2624	50 x 40(c) x 50	1



PRESS TO CRIMP ADAPTER - PEX



PRESS WATER TO CRIMP ADAPTER - PEX

PART N°	QF	SIZE (mm)	QTY
49VPWPCA1516	-	15 x 16	10
49VPWPCA2020	-	20 x 20	10
49VPWPCA2525	-	25 x 25	5

PRESS GAS TO CRIMP ADAPTER - PEX

PART N°	QF	SIZE (mm)	QTY
49VPGPCA1516	-	15 x 16	10
49VPGPCA2020	-	20 x 20	10
49VPGPCA2525	-	25 x 25	5

PRESS TO CRIMP ADAPTER - PEX MULTILAYER



PRESS WATER TO CRIMP ADAPTER - PEX MULTILAYER

PART N°	QF	SIZE (mm)	QTY
49VPWVPXA16	C2695	15 x 16	10
49VPWVPXA20	C2696	20 x 20	10
49VPWVPXA25	C2697	25 x 25	5

PRESS GAS TO CRIMP ADAPTER - PEX MULTILAYER

PART N°	QF	SIZE (mm)	QTY
49VPGVPXA16	C2533	15 x 16	10
49VPGVPXA20	C2534	20 x 20	10
49VPGVPXA25	C2535	25 x 25	5

PRESS TO SLIDE SOCKET ADAPTER



PRESS WATER TO SLIDE SOCKET ADAPTER

PART N°	QF	SIZE (mm)	QTY
49VPWPSA1516	C2808	15 x 16	5
49VPWPSA2020	C2809	20 x 20	5
49VPWPSA2525	C2810	25 x 25	5
49VPWPSA3232	C3873	32 x 32	1

PRESS GAS TO SLIDE SOCKET ADAPTER

PART N°	QF	SIZE (mm)	QTY
49VPGPSA1516	C3874	15 x 16	5
49VPGPSA2020	C3875	20 x 20	5
49VPGPSA2525	C3876	25 x 25	5
49VPGPSA3232	C3877	32 x 32	1

PRESS BRASS FEMALE LUGGED ELBOW W75



PRESS WATER BRASS FEMALE LUGGED ELBOW W75

PART N°	QF	SIZE (mm)	THREAD SIZE	QTY
49VPWFWE15	C2662	15	15FI	5
49VPWFWE20	C2663	20	20FI	5

PRESS BRASS MALE LUGGED ELBOW W45



WATER BRASS MALE LUGGED ELBOW W45

PART N°	QF	LENGTH (mm)	SIZE (mm)	THREAD SIZE	QTY
49VPWMWE15	C2670	90	15	15MI	5
49VPWMWE20	C2671	90	20	20MI	5

GAS BRASS MALE LUGGED ELBOW W45

PART N°	QF	LENGTH (mm)	SIZE (mm)	THREAD SIZE	QTY
49VPGMWE15	C2520	90	15	15MI	5

PRESS BRASS FEMALE ELBOW



PRESS WATER BRASS FEMALE ELBOW

PART N°	QF	SIZE (mm)	THREAD SIZE	QTY
49VPWFE1590	C2672	15	15FI	5
49VPWFE2090	C2673	20	20FI	5
49VPWFE2590	C2674	25	25FI	5

PRESS BRASS MALE ELBOW



PRESS WATER BRASS MALE ELBOW

PART N°	QF	SIZE (mm)	THREAD SIZE	QTY
49VPWME1590	C2675	15	15MI	5
49VPWME2090	C2676	20	20MI	5
49VPWME2590	C2677	25	25MI	5



COPPER PRESS BRASS MALE COUPLER



COPPER PRESS WATER BRASS MALE COUPLER

PART N°	QF	SIZE (mm)	THREAD SIZE	QTY
49VPWMI1515	C2686	15	15MI	10
49VPWMI1520	C2687	15	20MI	10
49VPWMI2015	C2688	20	15MI	5
49VPWMI2020	C2689	20	20MI	5
49VPWMI2520	C2690	25	20MI	5
49VPWMI2525	C2691	25	25MI	5
49VPWMI3232	C2692	32	32MI	1
49VPWMI4040	C2693	40	40MI	1
49VPWMI5050	C2694	50	50MI	1

COPPER PRESS GAS BRASS MALE COUPLER

PART N°	QF	SIZE (mm)	THREAD SIZE	QTY
49VPGMI1515	C2525	15	15MI	10
49VPGMI2015	C2526	20	15MI	5
49VPGMI2020	C2527	20	20MI	5
49VPGMI2520	C2528	25	20MI	5
49VPGMI2525	C2529	25	25MI	5
49VPGMI3232	C2530	32	32MI	1
49VPGMI4040	C2531	40	40MI	1
49VPGMI5050	C2532	50	50MI	1

COPPER PRESS BRASS FEMALE BARREL UNION



COPPER PRESS WATER BRASS FEMALE BARREL UNION

PART N°	QF	SIZE (mm)	THREAD SIZE	QTY
49VPWBF101515	C2657	15	15FI	10
49VPWBF102525	C2658	25	25FI	20
49VPWBF103232	C2659	32	32FI	10
49VPWBF104040	C2660	40	40FI	1
49VPWBF105050	C2661	50	50FI	1

COPPER PRESS BRASS MALE BARREL UNION



COPPER PRESS WATER BRASS MALE BARREL UNION

PART N°	QF	SIZE (mm)	THREAD SIZE	QTY
49VPBUMI1515	C2664	15	15MI	10
49VPBUMI2020	C2665	20	20MI	5
49VPBUMI2525	C2666	25	25MI	5
49VPBUMI3232	C2667	32	32MI	1
49VPBUMI4040	C2668	40	40MI	1
49VPBUMI5050	C2669	50	50MI	1

COPPER PRESS GAS BRASS MALE BARREL UNION

PART N°	QF	SIZE (mm)	THREAD SIZE	QTY
49VPGBUMI2020	C2515	20	20MI	5
49VPGBUMI2525	C2516	25	25MI	5
49VPGBUMI3232	C2517	32	32MI	1
49VPGBUMI4040	C2518	40	40MI	1
49VPGBUMI5050	C2519	50	50MI	1

COPPER PRESS BRASS FEMALE COUPLER



COPPER PRESS WATER BRASS FEMALE COUPLER

PART N°	QF	SIZE (mm)	THREAD SIZE	QTY
49VPWFI1515	C2678	15	15FI	10
49VPWFI2020	C2679	20	20FI	5
49VPWFI2525	C2680	25	25FI	5
49VPWFI3232	C2681	32	32FI	5
49VPWFI4040	C2682	40	40FI	5
49VPWFI5050	C2683	50	50FI	5

COPPER PRESS GAS BRASS FEMALE COUPLER

PART N°	QF	SIZE (mm)	THREAD SIZE	QTY
49VPGFI2020	C2521	20	20FI	5
49VPGFI2525	C2522	25	25FI	5
49VPGFI3232	C2523	32	32FI	5
49VPGFI4040	C2524	40	40FI	5



ACURA PRESS XL

Copper press XL has only three internal parts, the O-ring, grip ring and the seal. Both parts have an internal diameter larger than the tube, which allows for easy tube insertion and pre-press leak indication.

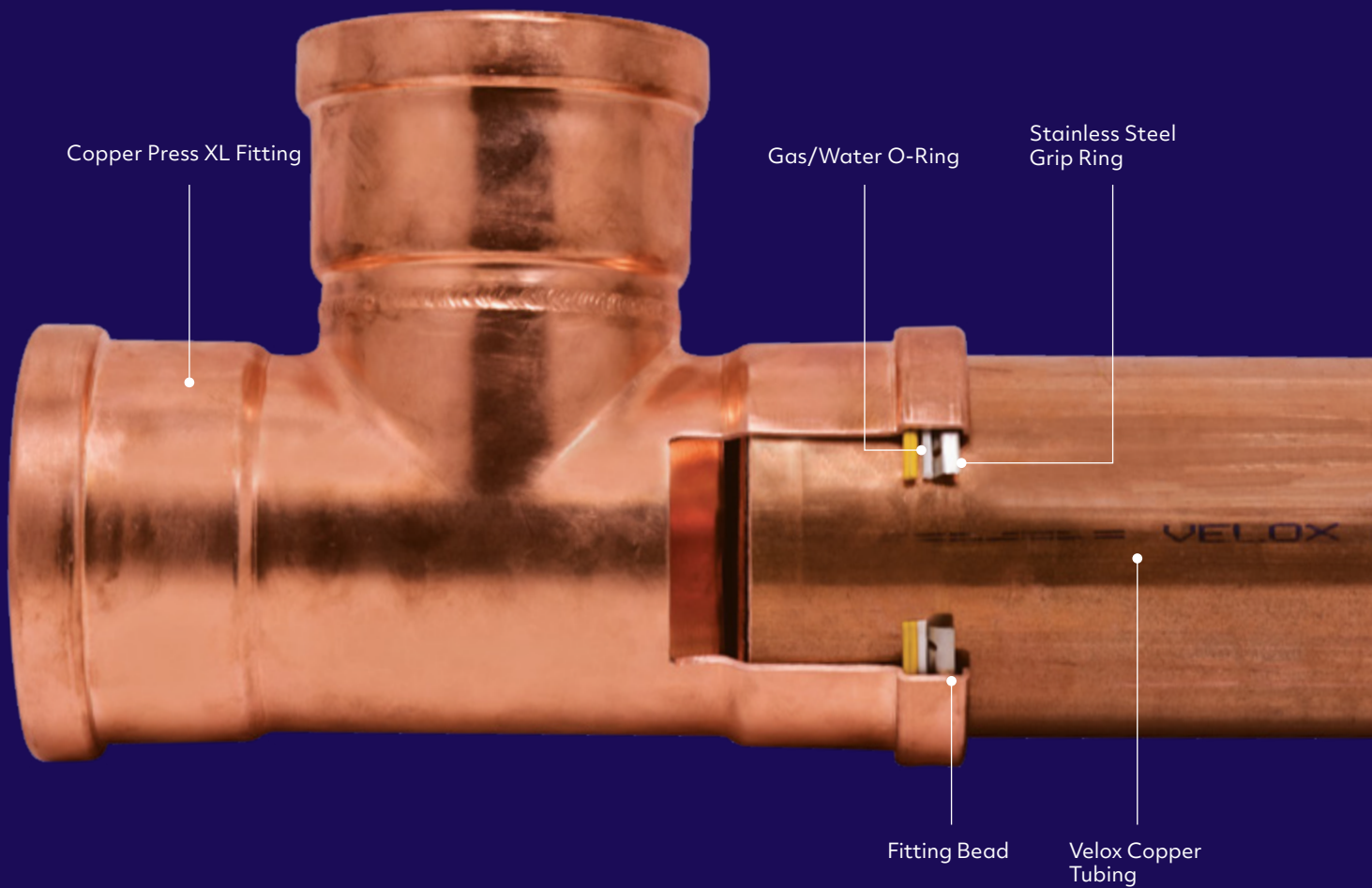



ACURA PRESS XL



The copper press XL range consists of fittings sized 65-100mm. Using a fast, secure and flame-free install process, copper press XL is easy to both install and inspect.

Copper press XL is installed with a hydraulic press tool with a compatibly sized V profile jaw. Once completed, the fitting forms a permanent and durable joint with the pipe and has a 25-year warranty ensuring you peace of mind.

All copper press XL fittings include a stainless steel grip ring with equally spaced collapse zones ensuring all round equal grip on the tube diameter and an even seal compression between tube and fitting after pressing.

PLUMBING

COPPER PRESS XL FITTINGS

COPPER PRESS XL UNEQUAL TEE



COPPER PRESS XL WATER UNEQUAL TEE			
PART N°	QF	SIZE (mm)	QTY
49VPXLWTR0655065	C2802	65 x 50(c) x 65	1
49VPXLWTR0805080	C2803	80 x 50(c) x 80	1
49VPXLWTR0806580	C2804	80 x 65(c) x 80	1
49VPXLWTR10050100	C2805	100 x 50(c) x 100	1
49VPXLWTR10065100	C2806	100 x 65(c) x 100	1
49VPXLWTR10080100	C2807	100 x 80(c) x 100	1
COPPER PRESS XL GAS UNEQUAL TEE			
PART N°	QF	SIZE (mm)	QTY
49VPXLGTR0655065	C2625	65 x 50(c) x 65	1
49VPXLGTR0805080	C2627	80 x 50(c) x 80	1
49VPXLGTR0806580	C2628	80 x 65(c) x 80	1
49VPXLGTR10050100	C2629	100 x 50(c) x 100	1
49VPXLGTR10065100	C2630	100 x 65(c) x 100	1
49VPXLGTR10080100	C2631	100 x 80(c) x 100	1

COPPER PRESS XL EQUAL TEE



COPPER PRESS XL WATER EQUAL TEE			
PART N°	QF	SIZE (mm)	QTY
49VPXLWT065	C2784	65	1
49VPXLWT080	C2785	80	1
49VPXLWT100	C2786	100	1
COPPER PRESS XL GAS EQUAL TEE			
PART N°	QF	SIZE (mm)	QTY
49VPXLGT065	C2606	65	1
49VPXLGT080	C2607	80	1
49VPXLGT100	C2608	100	1



COPPER PRESS XL FLANGE ADAPTER



COPPER PRESS XL WATER FLANGE ADAPTER

PART N°	QF	SIZE (mm)	QTY
49VPWFA065	C2708	65	1
49VPWFA080	C2709	80	1
49VPWFA100	C2710	100	1

COPPER PRESS XL REDUCING COUPLING



COPPER PRESS XL WATER REDUCING COUPLING

PART N°	QF	SIZE (mm)	QTY
49VPXLWRC06532	C2751	65 x 32	1
49VPXLWRC06540	C2752	65 x 40	1
49VPXLWRC06550	C2753	65 x 50	1
49VPXLWRC08040	C2754	80 x 40	1
49VPXLWRC08050	C2755	80 x 50	1
49VPXLWRC08065	C2756	80 x 65	1
49VPXLWRC10050	C3008	100 x 50	1
49VPXLWRC10065	C2757	100 x 65	1
49VPXLWRC10080	C2758	100 x 80	1

COPPER PRESS XL GAS REDUCING COUPLING

PART N°	QF	SIZE (mm)	QTY
49VPXLGRC06532	C2582	65 x 32	1
49VPXLGRC06540	C2583	65 x 40	1
49VPXLGRC06550	C2584	65 x 50	1
49VPXLGRC08040	C2585	80 x 40	1
49VPXLGRC08050	C2586	80 x 50	1
49VPXLGRC08065	C2587	80 x 65	1
49VPXLGRC10050	C2588	100 x 50	1
49VPXLGRC10065	C2589	100 x 65	1
49VPXLGRC10080	C2590	100 x 80	1

COPPER PRESS XL FITTING REDUCER



COPPER PRESS XL WATER FITTING REDUCER

PART N°	QF	SIZE (mm)	QTY
49VPXLWFR06540	C2722	65 x 40	1
49VPXLWFR06550	C2723	65 x 50	1
49VPXLWFR08050	C2724	80 x 50	1
49VPXLWFR08065	C2725	80 x 65	1
49VPXLWFR10050	C2726	100 x 50	1
49VPXLWFR10065	C2727	100 x 65	1
49VPXLWFR10080	C2728	100 x 80	1

COPPER PRESS XL GAS FITTING REDUCER

PART N°	QF	SIZE (mm)	QTY
49VPXLGFR06540	C2553	65 x 40	1
49VPXLGFR06550	C2554	65 x 50	1
49VPXLGFR08040	C2555	80 x 40	1
49VPXLGFR08050	C2556	80 x 50	1
49VPXLGFR08065	C2557	80 x 65	1
49VPXLGFR10050	C2558	100 x 50	1
49VPXLGFR10065	C2559	100 x 65	1



COPPER PRESS XL ELBOW 90DEG

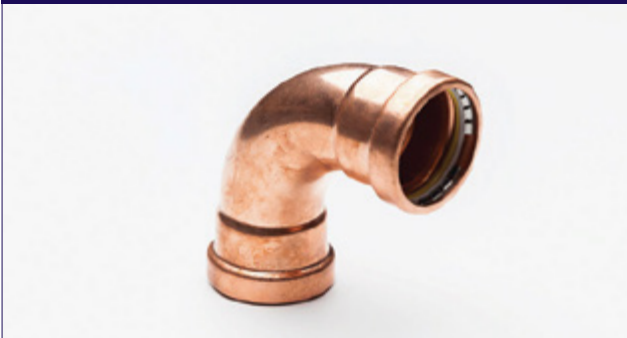

COPPER PRESS XL WATER ELBOW 90 DEGREE

PART N°	QF	SIZE (mm)	QTY
49VPXLW90E065	C2652	65	8
49VPXLW90E080	C2653	80	5
49VPXLW90E100	C2654	100	2

COPPER PRESS XL GAS ELBOW 90 DEGREE

PART N°	QF	SIZE (mm)	QTY
49VPXLG90E065	C2511	65	1
49VPXLG90E080	C2512	80	1
49VPXLG90E100	C2513	100	1

COPPER PRESS XL ELBOW 45DEG

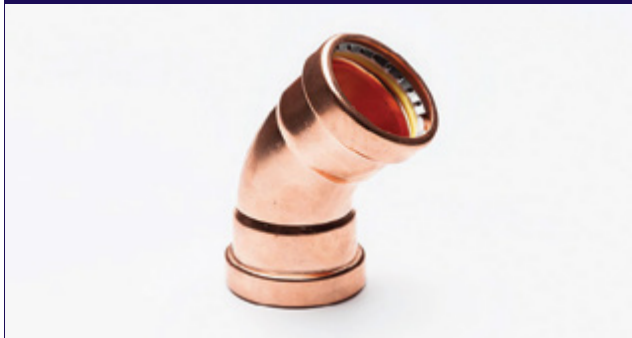

COPPER PRESS XL WATER ELBOW 45 DEGREE

PART N°	QF	SIZE (mm)	QTY
49VPXLW45E065	C2641	65	1
49VPXLW45E080	C2642	80	1
49VPXLW45E100	C2643	100	1

COPPER PRESS XL GAS ELBOW 45 DEGREE

PART N°	QF	SIZE (mm)	QTY
49VPXLG45E065	C2502	65	1
49VPXLG45E080	C2503	80	1
49VPXLG45E100	C2504	100	1

COPPER PRESS XL STRAIGHT COUPLING



COPPER PRESS XL WATER STRAIGHT COUPLING

PART N°	QF	SIZE (mm)	QTY
49VPXLWSC065	C2766	65	20
49VPXLWSC080	C2767	80	15
49VPXLWSC100	C2768	100	5

COPPER PRESS XL GAS STRAIGHT COUPLING

PART N°	QF	SIZE (mm)	QTY
49VPXLGSC065	C2597	65	1
49VPXLGSC080	C2598	80	1
49VPXLGSC100	C2599	100	1

COPPER PRESS XL SLIP COUPLING



COPPER PRESS XL WATER SLIP COUPLING

PART N°	QF	SIZE (mm)	QTY
49VPXLWSLP065	C2775	65	1
49VPXLWSLP080	C2776	80	1
49VPXLWSLP100	C2777	100	1

COPPER PRESS XL ROLL GROOVE ADAPTER



COPPER PRESS XL WATER ROLL GROOVE ADAPTER

PART N°	QF	SIZE (mm)	QTY
49VPXLWARGA100	C2759	100	1

COPPER PRESS XL END CAP



COPPER PRESS XL WATER END CAP

PART N°	QF	SIZE (mm)	QTY
49VPXLWEC065	C2704	65	1
49VPXLWEC080	C2705	80	1
49VPXLWEC100	C2706	100	1



COPPER TUBE

COPPER TUBE



W
AS 1432-2004
License No. WMKA 21221

COPPER TUBE - TYPE A

PART N°	QF	LENGTH (mm)	SIZE (mm)	QTY
49CTHD015	C2159	6000	100	1
49CTHD020A	C2160	6000	150	1

COPPER TUBE - TYPE B

PART N°	QF	LENGTH (mm)	SIZE (mm)	QTY
49CTHD015B	C2161	6000	15	1
49CTHD020	C2162	6000	20	1
49CTHD025	C2163	6000	25	1
49CTHD032	C2164	6000	32	1
49CTHD040	C2165	6000	40	1
49CTHD050	C2166	6000	50	1
49CTHD065	C2167	6000	65	1
49CTHD080	C2168	6000	80	1
49CTHD100	C2169	6000	100	1
49CTHD125	C2170	6000	125	1
49CTHD150	C2171	6000	150	1
49CTHD200	C2172	6000	200	1

COPPER TUBE - REFRIGERATION R410A



PART N°	LENGTH (mm)	SIZE (inch)	SIZE (mm)	QTY
49CTHDR14	6000	1/4	6.35	1
49CTHDR38	6000	3/8	9.5	1
49CTHDR12	6000	1/2	12.7	1
49CTHDR58	6000	5/8	15.88	1
49CTHDR34	6000	3/4	19	1
49CTHDR78	6000	7/8	22.2	1
49CTHDR1	6000	1	25.4	1
49CTHDR118	6000	1.125	28.6	1
49CTHDR138	6000	1.375	34.92	1
49CTHDR158	6000	1.625	41.28	1

Manufactured to Australian Standard AS1432, Acura copper pipes are designed to be strong and reliable and are fully compatible with our copper press and weld ranges of fittings.

Acura provides peace of mind knowing you're using the highest quality product combined with the best value for money for any gas or water piping system.

As a result of our direct supply partnership with the manufacturer, we are able to supply world-class piping at highly competitive prices.

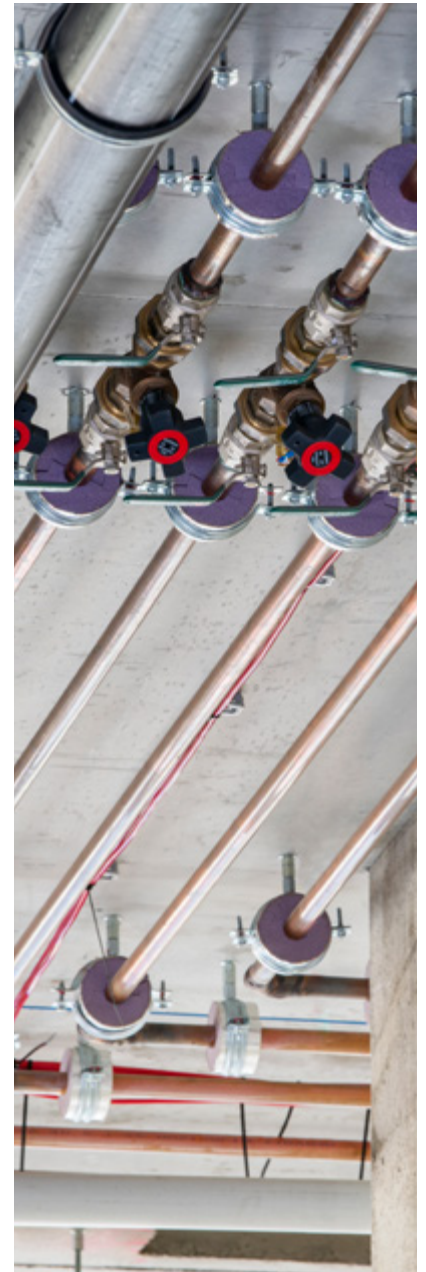



WELD FITTINGS

WELD COPPER EQUAL TEE

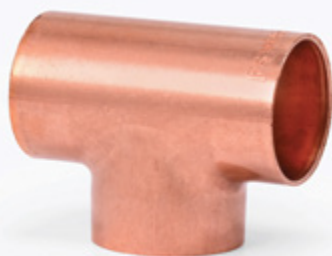

PART N°	QF	SIZE (mm)	QTY
49COPT020	C2148	20	10
49COPT025	C2149	25	5
49COPT032	C2150	32	10
49COPT040	C2151	40	8
49COPT050	C2152	50	5
49COPT065	C2153	65	6
49COPT080	C2154	80	3
49COPT100	C2155	100	1

WELD COPPER END CAP



PART N°	QF	SIZE (mm)	QTY
49COPEC020	C2077	20	10
49COPEC025	C2078	25	10
49COPEC032	C2079	32	10
49COPEC040	C2080	40	10
49COPEC050	C2081	50	10
49COPEC065	C2082	65	10
49COPEC080	C2083	80	10
49COPEC100	C2084	100	5

WELD COPPER 45 DEGREE ELBOW S - R



PART N°	QF	SIZE (mm)	QTY
49COP45SRE020	C2029	20	20
49COP45SRE025	C2030	25	20
49COP45SRE032	C2031	32	10
49COP45SRE040	C2032	40	10
49COP45SRE050	C2033	50	10
49COP45SRE065	C2034	65	5
49COP45SRE080	C2035	80	1
49COP45SRE100	C2036	100	1

WELD COPPER 90 DEGREE ELBOW S - RT



PART N°	QF	SIZE (mm)	QTY
49COP90SRE020	C2053	20	20
49COP90SRE025	C2054	25	10
49COP90SRE032	C2055	32	10
49COP90SRE040	C2056	40	5
49COP90SRE050	C2057	50	5
49COP90SRE065	C2058	65	3
49COP90SRE080	C2059	80	1
49COP90SRE100	C2060	100	1

WELD COPPER CONNECTOR



PART N°	QF	SIZE (mm)	QTY
49COPC020	C2064	20	10
49COPC025	C2065	25	10
49COPC032	C2066	32	10
49COPC040	C2067	40	10
49COPC050	C2068	50	10
49COPC065	C2069	65	5
49COPC080	C2070	80	1
49COPC100	C2071	100	1



Acura copper weld on fittings are manufactured in accordance with Australia Standard AS3688, and can be used for pressure and non-pressure applications.

WELD COPPER REDUCING CONNECTOR M - F



PART N°	QF	SIZE (mm)	QTY
49COPRC05025	C2100	50 x 25	10
49COPRC05032	C2101	50 x 32	10
49COPRC05040	C2102	50 x 40	10
49COPRC06532	C2103	65 x 32	10
49COPRC06540	C2104	65 x 40	10
49COPRC06550	C2105	65 x 50	20
49COPRC08040	C2106	80 x 40	10
49COPRC08050	C2107	80 x 50	10
49COPRC08065	C2108	80 x 65	10
49COPRC10050	C2109	100 x 50	5
49COPRC10065	C2110	100 x 65	5
49COPRC10080	C2111	100 x 80	1

WELD COPPER REDUCING CONNECTOR



PART N°	QF	SIZE (mm)	QTY
49COPRC02015	C2090	20 x 15	10
49COPRC02515	C2092	25 x 15	10
49COPRC02520	C2093	25 x 20	10
49COPRC03220	C2094	32 x 20	10
49COPRC03225	C2095	32 x 25	10
49COPRC04020	C2096	40 x 20	10
49COPRC04025	C2097	40 x 25	10
49COPRC04032	C2098	40 x 32	10
49COPRC05020	C2099	50 x 20	10

PLUMBING



◆ HVAC





CONTENTS	PAGE
PRESSURE PVC FITTINGS	80
PRESSURE PVC PIPE	80
CLEAR VINYL TUBING	81
HOSE CLAMPS	81
SPRING HANGER BOX KITS	81
SPRING HANGER KITS	82
HANGER BOXES	82
HANGER BOX SPRINGS	82
HANGER BOX ACCESSORIES	82
SEISMIC MOUNTS	83
NEOPRENE MOUNTS	84
WAFFLE PADS	84
ISOLATION RUBBERS	84
DUCT HANGERS	84
DUCT BOLTS	84
RUBBER WASHER ELEMENT	84
Z BRACKET	84
FOAM TAPE	85
PROTECTIVE FILM	85
DUCT STRAPPING	85
J CLEATS	85
REGISTER SPRINGS	85
HVAC PIPE SUPPORTS	86
MOUNTING SUPPORTS	87
HVAC REFRIGERATION PIPE	87
HVAC REFRIGERATION PAIR COIL	87



PRESSURE PVC FITTINGS

PRESSURE PVC TEE



PART N°	QF	SIZE (mm)	QTY
38STS05	D1232	15	20
38STS07	D1233	20	20
38STS10	D1234	25	20
38STS12	D1235	32	20

PRESSURE PVC ELBOW - 90 DEGREE



PART N°	QF	SIZE (mm)	QTY
38SLS05	D1218	15	20
38SLS07	D1219	20	20
38SLS10	D1220	25	20
38SLS12	D1221	32	20

PRESSURE PVC ELBOW - 45 DEGREE



PART N°	QF	SIZE (mm)	QTY
38SAS05	D1202	15	20
38SAS07	D1203	20	20
38SAS10	D1204	25	20
38SAS12	D1205	32	20

PRESSURE PVC COUPLING



PART N°	QF	SIZE (mm)	QTY
38SCS05	D1238	15	50
38SCS07	D1208	20	20
38SCS10	D1209	25	20

PRESSURE PVC FEMALE FAUCET SOCKET



* Pushed over pipe.

PART N°	QF	SIZE (mm)	QTY
38SFS05	D1213	15	20
38SFS07	D1214	20	20
38SFS10	D1215	25	20
38SFS12	D1237	32	20

PRES. PVC MALE VALVE TAKE OFF ADAPTOR

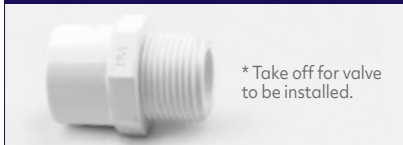

* Take off for valve to be installed.

PART N°	QF	SIZE (mm)	QTY
38SMA05	D1222	15	20
38SMA07	D1223	20	20
38SMA10	D1224	25	20

PRESSURE PVC MALE VALVE SOCKET

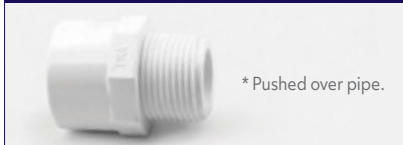

* Pushed over pipe.

PART N°	QF	SIZE (mm)	QTY
38SMS05	D1225	15	20
38SMS07	D1226	20	20
38SMS10	D1227	25	20

PRESSURE PVC END CAP



PART N°	QF	SIZE (mm)	QTY
38SKS05	D1240	15	20
38SKS07	D1216	20	20
38SKS10	D1217	25	20

PRES. PVC FEMALE FAUCET TAKEOFF ADAPTOR

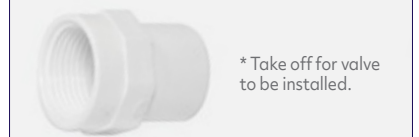

* Take off for valve to be installed.

PART N°	QF	SIZE (mm)	QTY
38SFA05	D1210	15	20
38SFA07	D1211	20	20
38SFA10	D1212	25	20

PRESSURE PVC REDUCER COUPLING



PART N°	QF	SIZE (mm)	QTY
38SRS0705	D1228	20-15	20
38SRS1007	D1229	25-20	20
38SRS1207	D1230	32-20	20
38SRS1211	-	40-20	20

PRESSURE PVC REDUCING BUSH



PART N°	QF	SIZE (mm)	QTY
38SBS0705	D1206	20-15	20
38SBS1007	D1207	25-20	20
38SBS1210	D1239	32-25	20

PRESSURE PVC PIPE

PRESSURE PVC PIPE

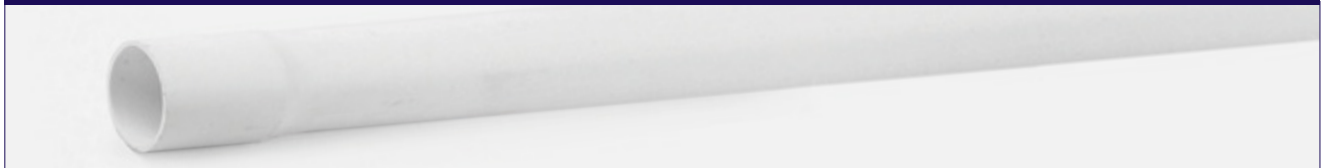

PART N°	QF	LENGTH (mm)	SIZE (mm)	QTY
38PPVC15	D1198	4000	15	10
38PPVC20	D1199	4000	20	5
38PPVC25	D1200	4000	25	5
38PPVC32	D1201	4000	32	5



CLEAR VINYL TUBING

CLEAR VINYL TUBING

* Per Metre



PART N°	QF	SIZE (mm)	WALL (mm)	QTY
38CVT06	D1177	6	1.5	30
38CVT10	D1170	10	1.5	30
38CVT12	D1171	12	2	30
38CVT16	D1172	16	2	30
38CVT20	D1173	20	2	30
38CVT25	D1174	25	3	30
38CVT32	D1175	32	3	30
38CVT40	D1176	40	-	30

HOSE CLAMPS

HOSE CLAMP



PART N°	SIZE (mm)	QTY
38MPC3	6-16	10
38MPC4	9-17	10
38MPC5	11-22	10
38MPCOA	14-27	10
38MPCO	18-32	10
38MPCI	21-44	10
38MPC2A	27-51	10
38MPC9	46-70	10
38MPC7	60-80	10
38MPC6	84-108	10
38MPC10	103-127	10
38MPC10A	130-155	10
38MPC8	146-197	10
38MPC11	181-225	10

METAL CLAMP ROLL STRAP & BUCKLE



PART N°	LENGTH (m)	QTY
14STRIP30SS	30	1
14STRIPDRIVSS	-	50

SPRING HANGER BOX KITS



Primarily used by those in the Mechanical industry, our innovative range of anti-vibration products are easy to install and incredibly effective in operation. We offer a comprehensive range of spring mounts, rubber mounts and isolation hangers which have been carefully tested and proven to isolate the source of vibration to create a silent and comfortable environment.

VIBRATROL COMPACT SERIES HANGER BOX KITS



PART N°	TYPE	MAX LOAD (kg)	SPRING COLOUR	QTY
35C10SH-KIT	Y10	10	SILVER	1
35C15SH-KIT	Y15	15	GOLD	1
35C30SH-KIT	Y30	30	BLACK	1
35C50SH-KIT	Y50	50	SILVER	1
35C60SH-KIT	Y60	60	BLUE	1

VIBRATROL HEAVY DUTY D-SERIES HANGER BOX KITS



PART N°	MAX LOAD (kg)	SPRING COLOUR	QTY
35D30SH-KIT	15-30	SILVER	1
35D45SH-KIT	22-45	GOLD	1
35D70SH-KIT	35-70	BLACK	1
35D100SH-KIT	50-100	SILVER / GREEN STRIPE	1
35D175SH-KIT	175		1



SPRING HANGER KITS

VIBRATROL HEAVY DUTY D-SERIES HANGER BOX SPRING KITS

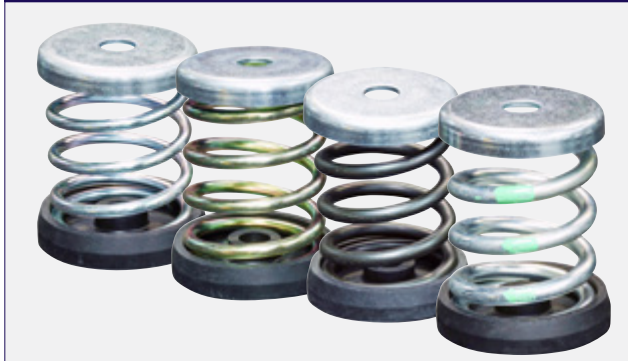

PART N°	MAX LOAD (kg)	SPRING COLOUR	QTY
35D30SH	15-30	SILVER	1
35D45SH	22-45	GOLD	1
35D70SH	35-70	BLACK	1
35D100SH	50-100	SILVER / GREEN STRIPE	1

HANGER BOXES

HANGER BOXES WITH RUBBER ELEMENT



PART N°	MAX LOAD (kg)	COLOUR	QTY
35NHB-L2	21	POWDER COATED WHITE	1
35NHB-A3	40	POWDER COATED WHITE	1

HANGER BOX SPRINGS

EMBELTON SPRINGS TO SUIT CLM MOUNTS



PART N°	MAX LOAD (kg)	SPRING COLOUR	QTY
35S-E91	35	VIOLET/BLACK	1
35S-E94	150	BLUE	1
35S-E95	200	BLACK	1
35S-E96	250	RED	1
35S-E97	300	GREEN	1
35S-E98	400	GREY	1
35S-E99	550	ORANGE	1
35S-E100	650	ORANGE / BLACK	1

EMBELTON SPRINGS TO SUIT CSM MOUNTS

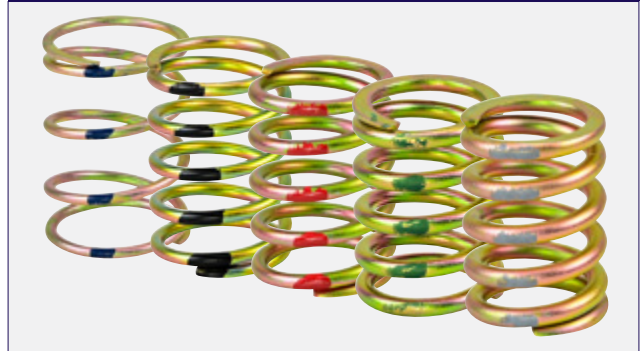

PART N°	MAX LOAD (kg)	SPRING COLOUR	QTY
35S-E10	15	BROWN	1
35S-E11	30	BLUE	1
35S-E12	50	BLACK	1
35S-E13	75	RED	1
35S-E14	125	GREEN	1
35S-E16	175	GREY	1
35S-E17	200	ORANGE	1

HANGER BOX ACCESSORIES

HANGER BOX M10 RUBBER ELEMENT



PART N°	QF	WORKING LOAD (kg)	QTY
35HD60	D1124	40	25

HANGER BOX RUBBER ELEMENTS

PART N°	MAX LOAD (kg)	COLOUR	QTY
35RHDE1-B	17	BLUE	1
35RHDE1-W	25	WHITE	1
35RHDE1-R	40	RED	1
35RHDE1-G	55	GREEN	1



SEISMIC MOUNTS

CSM SEISMIC MOUNT HOUSING



UP TO 200KG

PART N°	QF	QTY
35CSM	D1123	24

CLM SEISMIC MOUNT HOUSING



UP TO 650KG

PART N°	QF	QTY
35CLM	D1123	24

MASON RESTRAINED SEISMIC MOUNTS



PART N°	QTY
35SLR-A	1
35SLR-2A	1
35SLR-4A	1

ADJUSTABLE MOUNT - ASRM50 - SUPERMOUNT



121mm X 121mm

PART N°	DURO	COMPRESSION N (kg)	COLOUR	TOTAL HEIGHT MIN - MAX (mm)	QTY
35ASRM50-40A	40A	1000 (102)	RED	72 - 92	1
35ASRM50-55A	55A	2000 (204)	YELLOW	72 - 92	1
35ASRM50-70A	70A	4000 (408)	NONE	72 - 92	1

ADJUSTABLE MOUNT - ASRM75 - SUPERMOUNT



163mm X 163mm

PART N°	DURO	COMPRESSION N (kg)	COLOUR	TOTAL HEIGHT MIN - MAX (mm)	QTY
35ASRM75-40A	40A	2000 (204)	RED	88.5 - 113.5	1
35ASRM75-55A	55A	4000 (408)	YELLOW	88.5 - 113.5	1
35ASRM75-70A	70A	6000 (612)	NONE	88.5 - 113.5	1

ADJUSTABLE MOUNT - ASRM100 - SUPERMOUNT



186mm X 186mm

PART N°	DURO	COMPRESSION N (kg)	COLOUR	TOTAL HEIGHT MIN - MAX (mm)	QTY
35ASRM100-40A	40A	4000 (408)	RED	100 - 125	1
35ASRM100-55A	55A	8000 (816)	YELLOW	100 - 125	1
35ASRM100-70A	70A	12000 (1224)	NONE	100 - 125	1

ADJUSTABLE MOUNT - ASRMU40 - SUPERMOUNT SLIDE-IN



68mm X 68mm

PART N°	DURO	COMPRESSION N (kg)	COLOUR	TOTAL HEIGHT MIN - MAX (mm)	QTY
35ASRMU40-40A	40A	700 (71)	RED	55 - 70	1
35ASRMU40-55A	55A	1500 (153)	YELLOW	55 - 70	1
35ASRMU40-70A	70A	2000 (408)	NONE	55 - 70	1



NEOPRENE MOUNTS

NEOPRENE RUBBER CONDENSER MOUNTS



* Please Note: Packs of 4

PART N°	MAX LOAD (kg)	HEIGHT (mm)	QTY
35VM50	80	50	1
35VM75	80	75	1

NEOPRENE RUBBER STRUT MOUNTS BOLT ON



TOP SELLER

PART N°	MAX LOAD (kg)	HEIGHT (mm)	ID COLOUR	QTY
35WBM-A-BLUE	40-80	37	BLUE	1
35WBM-A-GREEN	25-50	37	GREEN	1
35WBM-A-RED	15-30	37	RED	1
35WBM-A-YELLOW	90-180	37	YELLOW	1

NEOPRENE RUBBER STRUT MOUNTS SLIDE IN

	PART N°	QTY
	35VMCB	4

SQUARE 4 HOLE NEOPRENE RUBBER MOUNTS



TOP SELLER

SQUARE 4 HOLE NEOPRENE RUBBER MOUNTS A-SERIES M8 THREAD

PART N°	MAX LOAD (kg)	HEIGHT (mm)	ID COLOUR	QTY
35NM-A-WHITE	7-20	41	WHITE	1
35NM-A-RED	15-40	41	RED	1
35NM-A-GREEN	30-60	41	GREEN	1
35NM-A-BLUE	50-100	41	BLUE	1

SQUARE 4 HOLE NEOPRENE RUBBER MOUNTS B-SERIES M10 THREAD

PART N°	MAX LOAD (kg)	HEIGHT (mm)	ID COLOUR	QTY
35NM-B-RED	30-70	50	RED	1
35NM-B-GREEN	50-100	50	GREEN	1
35NM-B-BLUE	80-160	50	BLUE	1
35NM-B-YELLOW	150-300	50	YELLOW	1

WAFFLE PADS

EMBELTON WAFFLE PADS

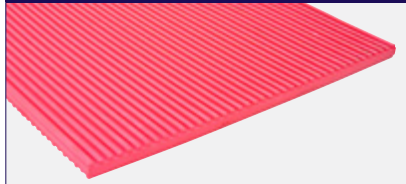

PART N°	SIZE (mm)	QTY
35SSHEAR-RED	450 x 450 x 17	12

SUPER WAFFLE PADS



PART N°	QF	SIZE (mm)	QTY
35SPAD	D1162	450 x 450 x 20	12

LIGHT DUTY WAFFLE PADS



PART N°	SIZE (mm)	QTY
35WPAD	450 x 450 x 10	10
35VWP10010	1000 x 100 x 10	10
35WPADTA	300 x 300 x 10	10

ISOLATION RUBBERS

RUBBER ISOLATOR WASHER ELEMENT



PART N°	QF	QTY
35M10IW	D1132	100

DUCT HANGERS

DUCT CORNER BRACKET



PART N°	QF	QTY
34CNR	D1101	200

DUCT BOLTS

M10 DUCT SCREW BOLT



PART N°	FINISH	LENGTH (mm)	QTY
12FCSZ35	ZINC	33	500

RUBBER WASHER ELEMENT



PART N°	WORKING LOAD (kg)	QTY
35KS196M10	30	100

Z BRACKET



PART N°	FINISH	WIDTH (mm)	Tek Holes	QTY
34DZC	ZINC	25	1	50
34DZC50	ZINC	50	2	50
34DZC50S	ZINC	50	4	50

M10 DUCT HANGER BOLT



PART N°	QTY
34HB10	100

FOAM TAPE

FOAM TAPE



PART N°	QF	SIZE (mm)	QTY
21FT3515	-	3.5 x 15	30
21FT5012	D1087	5 x 12	30
21FT5018	D1088	5 x 18	20
21FT5035	-	5 x 35	20

PROTECTIVE FILM

DUCTSHIELD PROTECTIVE FILM



PART N°	QF	SIZE (mm)	QTY
21DW600	D1085	600	1
21DW900	D1086	900	1
21DW1200	D1083	1200	1
21DW1500	D1084	1500	1

DUCT STRAPPING

DUCT STRAPPING



PART N°	QF	COLOUR	QTY
21BSTRAP	D1081	BLACK	48
21DHS	D1082	SILVER	16

FLEXIBLE DUCT STRAPPING



PART N°	LENGTH (m)	QTY
11FDS550	30	1
11FDS575	30	1

SUPERSTRAP DUCT STRAPPING



PART N°	DESCRIPTION	QTY
21DSSSD	SUPPORT SADDLE	1
21DSSS	SUPPORT STRAP 25MM X 60M	1
21DSSC	SUPPORT CLIP	1

J CLEATS

J CLEAT - LONG LEG



PART N°	QF	FINISH	QTY
33JCLL	D1091	ZINC	250
33JCLLSS	D1093	STAINLESS STEEL	250

J CLEAT - UNIVERSAL



* Refer page 193 for J Cleat Tool

PART N°	QF	QTY
33JCLU	D1092	250

REGISTER SPRINGS

REGISTER SPRING 10X35 PLATED

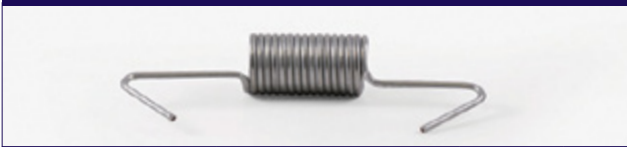

PART N°	QF	LENGTH (mm)	SIZE (mm)	FINISH	QTY
33RS103516P	D1096	35	10	PLATED	100

REGISTER SPRING 10X75 PLATED

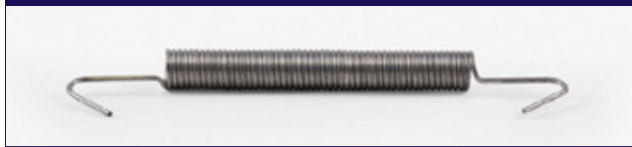

PART N°	QF	LENGTH (mm)	SIZE (mm)	FINISH	QTY
	D1098	75	10	PLATED	100

REGISTER SPRING 20X35 UNPLATED



PART N°	QF	LENGTH (mm)	SIZE (mm)	FINISH	QTY
33RS203516U	D1099	35	20	UNPLATED	100

REGISTER SPRING 10X75 UNPLATED

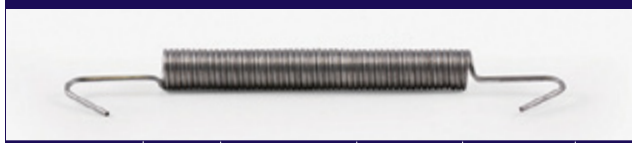

PART N°	QF	LENGTH (mm)	SIZE (mm)	FINISH	QTY
33RS107510U	D1097	75	10	UNPLATED	100



HVAC PIPE SUPPORTS

PLASTIC HANGERS



PART N°	UPPER PIPE SIZE (mm)	LOWER PIPE SIZE (mm)	QTY
16PCHP2	31	39	5
16PCHP3	34	44	5
16PCHP4	41	54	5

ROD CLIPS M10



PART N°	CLIP SIZE (inches)	PIPE SIZE (mm)	SUITS PIPE	QTY
16RPTR14	1/4"	6		10
16RPTR15	3/8"	12.7		10
16RPTR16	1/2"	9.5		10
16RPTR17	5/8"	15.87		10
16RPTR18	3/4"	18 - 20	20CU	10
16RPTR19	7/8"	22	15PVC	10
16RPTR20	1"	24 - 25	25CU / 20PVC	10
16RPTR21	1 1/8"	28		10
16RPTR22	1 1/4"	30 - 32	32CU	10
16RPTR23	1 3/8"	35 - 37	25PVC	10
16RPTR24	1 1/2"	38	32PVC	10
16RPTR25	1 5/8"	41		10
16RPTR26	2"	51		10

GRIP LOCK



* Approximate pipe sizes (allowing for 13mm insulation).

PART N°	FOR PIPE SIZE* (inches)	QTY
19GL1	1/4" - 1/2"	10
19GL2	3/8" - 5/8"	10
19GL3	1/2" - 7/8"	10
19GL4	5/8" - 1 1/8"	10

PIPE TIE



PART N°	SIZE (mm)	QTY
36PT40020-B	400 x 20	##

PLASTIC PIPE SLEEVES



PART N°	FOR PIPE SIZE (mm)	QTY
16BPS063HTB	63	10
16BPS080HTB	80	10



MOUNTING SUPPORTS

TOPHAT BASE

* Supplied individually.



PART N°	LENGTH (mm)	QTY
35TOPHAT-BASE	1200	1
35TOPHAT-BASE-1500	1500	1

TOPHAT SET

* Set of 2 bases & 2 tops.



PART N°	SIZE (mm)	QTY
35TOPHAT	1200	1*
35TOPHAT-1500	1500	1*

PACIFIC MOUNTS

* Set of 2.



PART N°	LENGTH (mm)	QTY
35IMB45080	450 X 80	1*

HVAC REFRIGERATION PIPE

COPPER TUBE - REFRIGERATION R410A



For lagging, please see page 57.

PART N°	LENGTH (mm)	SIZE (inch)	SIZE (mm)	QTY
49CTHDR14	6000	1/4	6.35	1
49CTHDR38	6000	3/8	9.5	1
49CTHDR12	6000	1/2	12.7	1
49CTHDR58	6000	5/8	15.88	1
49CTHDR34	6000	3/4	19	1
49CTHDR78	6000	7/8	22.2	1
49CTHDR1	6000	1	25.4	1
49CTHDR118	6000	1.125	28.6	1
49CTHDR138	6000	1.375	34.92	1
49CTHDR158	6000	1.625	41.28	1

HVAC REFRIGERATION PAIR COIL

COPPER PAIR COIL - REFRIGERATION R410A



PART N°	LENGTH (meters)	SIZE (inch)	INSULATION THICKNESS (mm)	QTY
49PC1412FR13	20	1/4 x 1/2	13	1
49PC1412FR19	18	1/4 x 1/2	19	1
49PC1438FR13	20	1/4 x 3/8	13	1
49PC1438FR19	18	1/4 x 3/8	19	1
49PC1458FR13	20	1/4 x 5/8	13	1
49PC1458FR19	18	1/4 x 5/8	19	1
49PC3834FR13	20	3/8 x 3/4	13	1
49PC3834FR19	18	3/8 x 3/4	19	1
49PC3858FR13	20	3/8 x 5/8	13	1
49PC3858FR19	18	3/8 x 5/8	19	1



◆ Electrical





Electrical

CONTENTS	PAGE
STUDBITE	90
STUDBITE ACCESSORIES	90
ECT CABLE TRAY & ACCESSORIES	91
AT3 CABLE TRAY & ACCESSORIES	92
AT5 CABLE TRAY & ACCESSORIES	93
FIRE RATED CABLE LADDER	94
FIRE RATED CABLE TRAY	94
FIRE RATED CABLE TRAY ACCESSORIES	95
PERFORATED CABLE TRAY	96
CABLE MESH BASKET	96
CON-LOCK FIXINGS	96
ZIP-CLIP LOCK	96
CATENARY WIRE	96
WIRE ROPE	96
CONDUIT	97
ELECTRICAL CONSUMABLES	97
CLIPS & SADDLES	97



STUDBITE

FAST - EFFICIENT - SMART

- Reduce install times by over 50%
- Reduces on-site labour costs
- Reduces materials required
- Remove on-site frustration
- Compatible with existing & traditional installation systems



INSTALL-READY TRAPEZE SUPPORTS

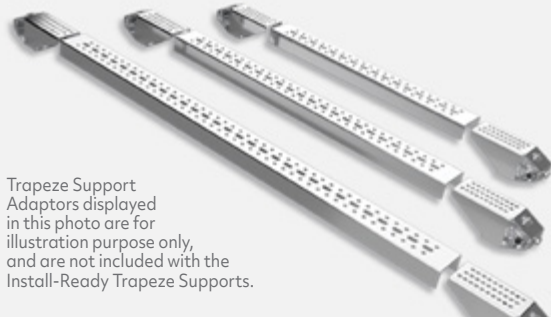

Trapeze Support Adaptors displayed in this photo are for illustration purpose only, and are not included with the Install-Ready Trapeze Supports.

PART N°	FINISH	LENGTH (mm)	QTY
41FCS-TS300	ZINC	300	10
41FCS-TS450	ZINC	450	10
41FCS-TS600	ZINC	600	10

TRAPEZE SUPPORT ADAPTOR

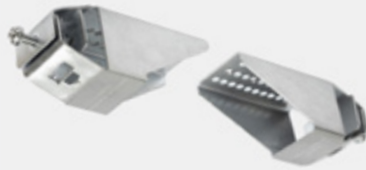

PART N°	FINISH	QTY
41FCS-TSA	ZINC	2

MULTI-FIX SINGLE STUD HANGER



PART N°	FINISH	LENGTH (mm)	QTY
41FCS-MSH100	ZINC	100	1
41FCS-MSH150	ZINC	150	1
41FCS-MSH225	ZINC	225	1
41FCS-MSH300	ZINC	300	1

STUDBITE ACCESSORIES

STUDBITE RETROFIT CLAMP



PART N°	FINISH	QTY
41FCS-MSH-C	ZINC	1

STUDBITE PH2 SCREWS



PART N°	FINISH	QTY
41FCS-B610	ZINC	1

BASKET TRAY CLAMP



PART N°	FINISH	QTY
41FCS-BTC	ZINC	1



ECT CABLE TRAY

ECT CABLE TRAY



ECT CABLE TRAY

OUR MOST POPULAR AND ECONOMICAL CABLE TRAY PRODUCT

PART N°	FINISH	WIDTH (mm)	HEIGHT (mm)	LENGTH (mm)	QTY
41ECT150	GAL	150 OD	45	3000	1
41ECT300	GAL	300 OD	45	3000	1
41ECT450	GAL	450 OD	45	3000	1
41ECT600	GAL	600 OD	45	3000	1
41ECT150HDG	HDG	150 OD	45	3000	1
41ECT300HDG	HDG	300 OD	45	3000	1
41ECT450HDG	HDG	450 OD	45	3000	1
41ECT600HDG	HDG	600 OD	45	3000	1

ECT CABLE TRAY ACCESSORIES

ECT CABLE TRAY HOLD DOWN BRACKETS



PART N°	FINISH	HEIGHT (mm)	QTY
41ECTHDB	GAL	45	1
41ECTHDBH	HDG	45	1

ECT CABLE TRAY DIVIDER STRIPS



PART N°	FINISH	LENGTH (mm)	QTY
41ECTDSG	GAL	3000	1

ECT CABLE TRAY JOINER BOLTS AND NUTS



PART N°	ITEM	FINISH	QTY
41DTNZ	NUT	ZINC	1
41DTBZ	BOLT	ZINC	1

ECT CABLE TRAY RADIUS PLATES



PART N°	FINISH	LENGTH (mm)	QTY
41ECTRPG	GAL	2000	1
41ECTRPG-3	GAL	3000	1
41ECTRPH	HDG	2000	1

ECT CABLE TRAY RISER PLATES



PART N°	FINISH	QTY
41ECTRLG	GAL	1
41ECTRLGH	HDG	1

ECT CABLE TRAY TRAPEZE SUPPORTS



PART N°	FINISH	SIZE (mm)	QTY
41ECTTS150G	GAL	150	1
41ECTTS300G	GAL	300	1
41ECTTS450G	GAL	450	1
41ECTTS600G	GAL	600	1

ECT CABLE TRAY SPLICE PLATES



PART N°	FINISH	QTY
41ECTSPG	GAL	1
41ECTSPH	HDG	1

ECT CABLE TRAY TEE CROSS BRACKET



PART N°	FINISH	QTY
41ECTTXG	GAL	1

ECT CABLE TRAY COVERS



PART N°	FINISH	WIDTH (mm)	LENGTH (mm)	TYPE	QTY
41ECTFC150	GAL	150	2400	FLAT	1
41ECTFC300	GAL	300	2400	FLAT	1
41ECTFC450	GAL	450	2400	FLAT	1
41ECTFC600	GAL	600	2400	FLAT	1
41ECTPC150	GAL	150	2400	PEAKED	1
41ECTPC300	GAL	300	2400	PEAKED	1



AT3 CABLE TRAY

AT3 CABLE TRAY



PART N°	FINISH	WIDTH (mm)	HEIGHT (mm)	LENGTH (mm)	QTY
41DT3150	GAL	172 OD - 150 ID	50	3000	1
41DT3300	GAL	322 OD - 300 ID	50	3000	1
41DT3450	GAL	472 OD - 450 ID	50	3000	1
41DT3600	GAL	622 OD - 600 ID	50	3000	1

AT3 CABLE TRAY ACCESSORIES

AT3 CABLE TRAY HOLD DOWN BRACKETS



PART N°	FINISH	HEIGHT (mm)	QTY
41DT3HDB	GAL	50	1

AT3 CABLE TRAY JOINER BOLTS AND NUTS



PART N°	FINISH	QTY
41DT3BN-G	HDG	1

AT3 CABLE TRAY TEE CROSS BRACKET



PART N°	FINISH	QTY
41KT3TXH	HDG	1
41DT3TXG	GAL	1

AT3 CABLE TRAY RADIUS PLATES



PART N°	FINISH	LENGTH (mm)	QTY
413RPH	HDG	3000	1
41KT3RPG	GAL	3000	1
41DT3RG	GAL	3000	1

AT3 CABLE TRAY RISER PLATES



PART N°	FINISH	QTY
41DT3RL	GAL	1
41KT3LPG	GAL	1
413LPH	HDG	1

AT3 CABLE TRAY SPLICE PLATES



PART N°	FINISH	QTY
41DT3SPG	GAL	1

STRUT SUPPORT



AT5 CABLE TRAY

AT5 CABLE TRAY



PART N°	FINISH	WIDTH (mm)	HEIGHT (mm)	LENGTH (mm)	QTY
41DT5300	GAL	300	85	3000	1
41DT5450	GAL	450	85	3000	1
41DT5600	GAL	600	85	3000	1
41DT5150HDG	HDG	150	85	3000	1
41DT5300HDG	HDG	300	85	3000	1
41DT5600HDG	HDG	600	85	3000	1

AT5 CABLE TRAY ACCESSORIES

AT5 CABLE TRAY HOLD DOWN BRACKETS



PART N°	FINISH	HEIGHT (mm)	QTY
41DT5HDB	GAL	85	1
41DT5HDBHDG	HDG	85	1

AT5 CABLE TRAY TEE CROSS BRACKET



PART N°	FINISH	QTY
41DT5TXHDG	HDG	1

AT5 CABLE TRAY RADIUS PLATES



PART N°	FINISH	LENGTH (mm)	QTY
41DT5RPG	GAL	3000	1
41DT5RPHDG	HDG	3000	1

AT5 CABLE TRAY RISER PLATES



PART N°	FINISH	QTY
41ECT5RLG	GAL	1

AT5 CABLE TRAY SPLICE PLATES



PART N°	FINISH	QTY
41DT5SPG	GAL	1
41DT5SPHDG	HDG	1

AT5 CABLE TRAY COVERS



PART N°	FINISH	WIDTH (mm)	LENGTH (mm)	QTY
41DT5FC300	GAL	320	2400	1
41DT5FC600	GAL	630	2400	1



FIRE RATED CABLE LADDER

FIRE RATED CABLE LADDER / FIRE RATED CABLE LADDER KIT



FIRE RATED CABLE LADDER

PART N°	FINISH	WIDTH (mm)	HEIGHT (mm)	LENGTH (mm)	QTY
41DCL150N2FRHDG	HDG	150	93	6000	1
41DCL300N2FRHDG	HDG	300	93	6000	1
41DCL600N2FRHDG	HDG	600	100	6000	1

FIRE RATED CABLE LADDER KIT

PART N°	FINISH	WIDTH (mm)	HEIGHT (mm)	LENGTH (mm)	QTY
41CLFR3C15HK	HDG	150	100	6000	1
41CLFR3C30HK	HDG	300	100	6000	1
41CLFR3C45HK	HDG	450	100	6000	1
41CLFR3C60HK	HDG	600	100	6000	1

FIRE RATED CABLE TRAY

FIRE RATED CABLE TRAY



AT3 FIRE RATED CABLE TRAY

PART N°	FINISH	DUTY LEVEL	WIDTH (mm)	HEIGHT (mm)	LENGTH (mm)	QTY
41FRM315HK	HDG	MD	150	50	3000	1
41FRL315GK	GAL	LD	150	50	3000	1
41FRL315HK	HDG	LD	150	50	3000	1
41FRM3150GK	GAL	MD	150	50	3000	1
41FRH315GK	GAL	HD	150	50	3000	1
41FRM330GK	GAL	MD	300	50	3000	1
41FRH360GK	GAL	HD	600	50	3000	1
41FRH330HK	HDG	HD	300	50	3000	1
41FRH330GK	GAL	HD	300	50	3000	1
41FRH345GK	GAL	HD	450	50	3000	1

AT5 FIRE RATED CABLE TRAY

PART N°	FINISH	DUTY LEVEL	WIDTH (mm)	HEIGHT (mm)	LENGTH (mm)	QTY
41FRL515GK	GAL	LD	150	85	3000	1



FIRE RATED CABLE TRAY ACCESSORIES

AT3 FIRE RATED CABLE TRAY HANGER KITS

PART N°	FINISH	DUTY LEVEL	QTY
41FRL3HCHK	HDG	LD	1
41FRL3HCGK	GAL	LD	1

AT3 FIRE RATED CABLE TRAY HANGERS

PART N°	FINISH	QTY
41LTH2	GAL	1

AT3 FIRE RATED CABLE TRAY SPLICE PLATES

PART N°	FINISH	DUTY LEVEL	QTY
41FR3SPG	GAL	MD	1
41FRH3SPGK	GAL	HD	1

FIRE RATED CABLE TRAY JOINER BOLTS

PART N°	FINISH	QTY
41KTBZ	ZINC	1

FIRE RATED CABLE TRAY JOINER NUTS

PART N°	FINISH	QTY
41KTNZ	ZINC	1

FIRE RATED CABLE TRAY ANGLE BRACKETS

PART N°	FINISH	DUTY LEVEL	ANGLE	QTY
411026H	HDG	MD	90D	1
41FRABHDG	HDG	HD	90D	1

AT3 FIRE RATED CABLE TRAY HOLD DOWN BRACKETS

PART N°	FINISH	DUTY LEVEL	QTY
41FRH3HDB	GAL	HD	1
41FRM3HDB	GAL	MD	1
41FR3HDCH	HDG	MD	1
41FR5HDCG	GAL	HD	1

FIRE RATED CABLE TRAY SPLICE KITS

AT3 FIRE RATED CABLE TRAY SPLICE KITS

PART N°	FINISH	DUTY LEVEL	QTY
41FRL3SPGK	GAL	LD	1
41FRM3SPGK	GAL	MD	1
41FRM3SPHK	HDG	MD	1
41FRH3SPHK	HDG	HD	1

AT5 FIRE RATED CABLE TRAY SPLICE KITS

PART N°	FINISH	DUTY LEVEL	QTY
41FRL5SPGK	GAL	LD	1
41FRL3SPHK	HDG	LD	1

AT3 FIRE RATED CABLE TRAY TRAPEZE KITS

PART N°	FINISH	DUTY LEVEL	QTY
41FRH3T30GK	GAL	HD	1
41FRM3T15GK	GAL	MD	1
41FRM3T30GK	GAL	MD	1
41FRH3T15GK	GAL	HD	1
41FRH3T45GK	GAL	HD	1
41FRH3T60GK	GAL	HD	1



PERFORATED CABLE TRAY

PERFORATED CABLE TRAY



PART N°	FINISH	WIDTH (mm)	HEIGHT (mm)	LENGTH (mm)	QTY
41DAPT075	GAL	75	14	2400	1
41DAPT100	GAL	100	14	2400	1
41DAPT150	GAL	150	14	2400	1
41DAPT300	GAL	300	14	2400	1
41DAPT450	GAL	450	14	2400	1
41DAPT75	GAL	75	14	2400	1
41DAPT150HDG	HDG	150	14	2400	1
41DAPT300HDG	HDG	300	14	2400	1

CABLE MESH BASKET

CABLE MESH BASKET

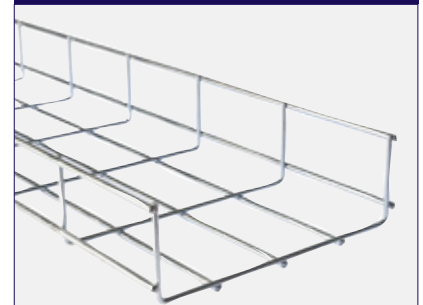

PART N°	WIDTH (mm)	LENGTH (mm)	QTY
41MB150	150	3000	1
41MB450	450	3000	1
41MB600	600	3000	1

CON-LOCK FIXINGS

2MM / 3MM CON-LOCK ENDS



ZIP-CLIP LOCK

ZIP-CLIP LOCK



PART N°	QF	SIZE (mm)	WORKING LOAD (kg)	QTY
17ZCR1	-	1	10	10
17ZCR2	A0578	2	50	10
17ZCR3	A0646	3	120	10
17ZCR4	A0674	4	230	10

CATENARY WIRE

COATED CATENARY WIRE ROPE



PART N°	ROLL LENGTH	QTY
17CATCOATED100	100m	1
17CATCOATED200	200m	1
17CATCOATED500	500m	1

WIRE ROPE

WIRE ROPE



PART N°	SIZE (mm)	ROLL LENGTH	QTY
17CAT1-200	1	200m	1
17CAT2-100	2	100m	1
17CAT2-200	2	200m	1
17CAT2-250	2	250m	1
17CAT2-500	2	500m	1
17CAT2-1000	2	1000m	1
17CAT3-50	3	50m	1
17CAT3-100	3	100m	1
17CAT3-200	3	200m	1
17CAT3-250	3	250m	1
17CAT4-50	4	50m	1
17CAT4-100	4	100m	1
17CAT6-50	6	50m	1

WIRE ROPE GRIP



PART N°	FINISH	SIZE	QTY
17WRGM3	ZINC	3MM	1
17WRGM3SS	SS	3MM	1
17WRGM4SS	SS	4MM	1
17WRGM5	ZINC	5MM	1
17WRGM6G	GALV	6MM	1
17WRGM8	ZINC	8MM	1

WIRE ROPE ACCESSORIES

More wire rope accessories on page 29.

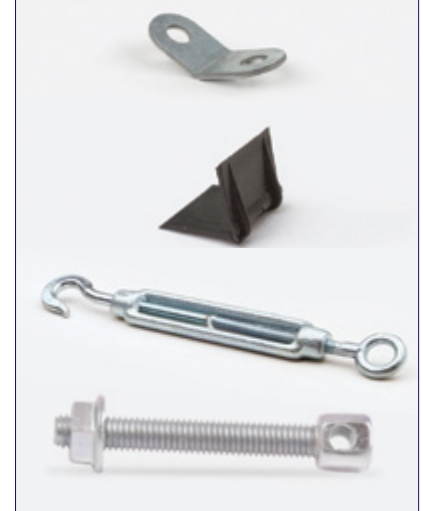



CONDUIT

GREY RIGID CONDUIT



PART N°	QF	SIZE (mm)	LENGTH (mm)	QTY
41RC20G	E0947	20	4000	15
41RC25G	E0951	25	4000	10
41RC32G	E0954	32	4000	10

ORANGE SWEEP BEND



PART N°	QF	SIZE (mm)	QTY
41SB20O	E0982	20	20
41SB25O	E0983	25	20
41SB32O	E0984	32	20
41SB40O	E0985	40	10
41SB50O	E0986	50	10

ELECTRICAL CONSUMABLES

ELECTRICAL TAPE



PART N°	QF	COLOUR	QTY
21ETAPEMIX	E0304	RAINBOW PCK	1
21ETAPEBLU	E0300	BLUE	10
21ETAPEBLA	E0301	BLACK	10
21ETAPEEAR	E0302	GREEN/YELLOW	10
21ETAPERED	E0303	RED	10
21ETAPEWHI	E0305	WHITE	10

CLIPS AND SADDLES

HALF SADDLE



PART N°	QF	SIZE (mm)	FINISH	QTY
16SG16	E0294	16	ZINC	100
16SG20	E0295	20	ZINC	100
16SG25	E0296	25	ZINC	100
16SG32	E0297	32	ZINC	50
16SG40	E0298	40	ZINC	40
16SG50	E0299	50	ZINC	20

ORANGE CORRUGATED CONDUIT



PART N°	QF	SIZE (mm)	LENGTH (mtr)	QTY
41CC02050	E0345	20	50	1
41CC02550	E0346	25	50	1
41CC03225	E0347	32	25	1
41CC04025	E0348	40	10	1

ORANGE RIGID CONDUIT



PART N°	QF	SIZE (mm)	LENGTH (mm)	QTY
41RC20O	E0948	20	4000	15
41RC25O	E0952	25	4000	10
41RC32O	E0955	32	4000	10
41RC40O	E0957	40	4000	10
41RC50O	E0958	50	4000	5

PLASTIC STUD GROMMET



* Refer page 142 for Stud Punch.

PART N°	QF	HOLE SIZE (mm)	QTY
26ESGP	I0834	34	100

COBRA MOUNT

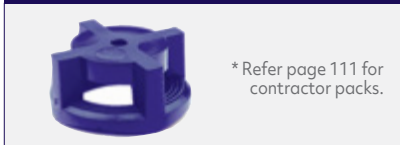

* Refer page 111 for contractor packs.

PART N°	QF	TO SUIT	QTY
0855074	F0579	DXG3000/COBRA V	100

FULL SADDLE



PART N°	QF	SIZE (mm)	FINISH	QTY
16EFS20	E0289	20	ZINC	100
16EFS25	E0290	25	ZINC	100
16EFS32	E0291	32	ZINC	50
16EFS40	E0292	40	ZINC	45
16EFS50	E0293	50	ZINC	40

GREY CORRUGATED CONDUIT



PART N°	QF	SIZE (mm)	LENGTH (mtr)	QTY
41CC2050	E0335	20	50	1
41CC2550	E0336	25	50	1
41CC3225	E0337	32	25	1
41CC4010	E0338	40	10	1
41CC5010	E0340	50	10	1

PASSIVE FIRE PENETRATION SEALS

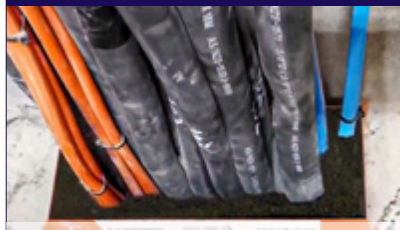

* Refer page 47 for passive fire penetration seals.

TELSTRA ROPE - 6MM



PART N°	QF	SIZE	QTY
17TROPE	E1007	400MTR	1

PULL LINE - 3MM



PART N°	BREAK	SIZE	QTY
17TROPE1000	90KG	1000MTR	1

GIRDER CLIP



PART N°	QF	SIZE (mm)	QTY
15GC1620	E0287	16-20	100
15GC2532	E0288	25-32	100



◆ Fasteners & Fixings





CONTENTS	PAGE
VERTIGOS	100
DROP-IN ANCHORS	100
CONCRETE SCREW ANCHORS	102
CONCRETE INSERTS	103
SLEEVE ANCHORS	103
SUSPENSION ANCHORS	104
THROUGH BOLTS	105
SEISMIC RATED THROUGH BOLTS	105
SCREW BOLTS	106
SEISMIC RATED CONCRETE SCREW BOLTS	107
CHEMICAL ANCHORS	107
MASONRY PLUGS	108
METAL PIN ANCHORS	108
SPIKES	108
WALL DOGS	108
CAVITY FIXINGS	109
PLASTIC PLUGS	109
NYLON ANCHORS	110
GAS FIXINGS	110
PA FIXINGS	112
PLASTERBOARD FIXINGS	112
INSULATION FIXINGS	113
CABLE TIES	114
BOLTS	114
NUTS	118
METAL THREADS	119
HEADLESS SCREWS	119
TIE WIRES	119
WASHERS	120
NAILS	120
DRILLPOINT SCREWS	121
TYPE 17 SCREWS	123
NEEDLEPOINT SCREWS	124
RIVETS	125



VERTIGOS

VERTIGO - VERTICAL TIMBER



PART N°	QF	LENGTH (mm)	THREAD SIZE	QTY
1528040	A0247	25	M6	100
1528044	A0248	50	M10	100
1528060	A0249	25	M8	100
1528125	A0254	25	M10	100

STEEL AND TIMBER VERTIGO SOCKET DRIVER



PART N°	QF	QTY
157187	J0196	5

DROP-IN ANCHORS

DROP-IN ANCHOR - ZINC



PART N°	QF	LENGTH (mm)	HOLE SIZE (mm)	THREAD SIZE	QTY
02D6M	F0127	25	8	M6	100
02D8M	F0129	30	10	M8	100
02D10M30	F0115	30	12	M10	50
02D10M40	F0117	40	12	M10	50
02D12M	F0119	50	15/16	M12	50
02D16M	F0123	67	20	M16	25
02D20M	F0125	83	25	M20	25

HOLLOW SET DROP-IN ANCHOR



* Refer page 144 for Setting Tools.

PART N°	QF	HOLE SIZE (mm)	THREAD SIZE	QTY
02HSDIM10	F0137	16	M10	100

VERTIGO - VERTICAL STEEL



PART N°	QF	LENGTH (mm)	THREAD SIZE	QTY
1528000	A0244	25	M6	100
1528008	A0245	25	M10	100
1528024	A0246	25	M8	100

VERTIGO - HORIZONTAL STEEL



PART N°	QF	LENGTH (mm)	THREAD SIZE	QTY
1528100	A0251	25	M10	100
1528114	A0253	25	M12	100

VERTIGO - HORIZONTAL TIMBER



PART N°	QF	LENGTH (mm)	THREAD SIZE	QTY
1528128	A0255	50	M10	100

DROP-IN ANCHOR - STAINLESS STEEL



PART N°	QF	LENGTH (mm)	HOLE SIZE (mm)	THREAD SIZE	QTY
02D8MSS	F0130	30	10	M8	100
02D10M40SS	F0118	40	12	M10	50
02D12MSS	F0122	50	15/16	M12	50

DROP-IN ANCHOR - BUCKET



PART N°	QF	LENGTH (mm)	HOLE SIZE (mm)	THREAD SIZE	QTY
02D10M30BUCKET	F0116	30	12	M10	500
02D10M40BUCKET	-	40	12	M10	500
02D12M15BUCKET	F0120	50	16	M12	300



Fischer UltraCut FBS II™

The Fischer concrete screw UltraCut FBS II is made of zinc-plated steel with an internal thread. It is perfectly designed for applications like fixings of pipe routes, channel systems, ventilation ducts and facilities in the building service engineering.



Fischer UltraCut FBS II seismic anchor rod hanger

Fast and reliable solution

When the concrete screw is screwed into the drill hole using an impact driver, the thread flanks cut deep into the concrete, thus ensuring top load-bearing capacity. The low drilling effort saves time in the case of multiple fixations. The European Technical Approval for cracked concrete and non-cracked concrete as well as for seismic loads and classification into fire resistance class R120 guarantee even more safety.



Fire Rated

R120 (refer to ETA-15/0352 and ETA-18/0242 for load capacities under fire)



ETA-15/0352

Cracked & uncracked concrete
ETA-18/0242
Redundant non-structural applications

Features

- Approved for multiple use of non-load bearing systems and thereby ideal for the installation of pipe routes, cable trays and prestressed hollow concrete ceilings
- The design of the concrete screw with step thread offers maximum flexibility when mounting threaded rods or connecting elements
- Only requires 40mm embedment (seismic approved)
- ETA approved for cracked and uncracked concrete
- ETA approved for seismic loading
- ETA approved for redundant non-structural applications (6mm)
- R120 fire rated



Seismic C1

C1 on sizes with ETA approval

Independently tested and approved for use on solid uncracked / cracked concrete, and hollow core concrete.





CONCRETE SCREW ANCHORS

SEISMIC SCREW ANCHOR ROD HANGER



PART N°	LENGTH (mm)	HOLE SIZE (mm)	THREAD SIZE	QTY
08PB2M1040	40	6	M10	50

C1 TSM SCREW ANCHOR



PART N°	LENGTH (mm)	HOLE SIZE (mm)	SOCKET SIZE (mm)	QTY
17ZTSM06043	43	6	13	100

C2 SCREW ANCHOR ROD HANGER



PART N°	LENGTH (mm)	HOLE SIZE (mm)	THREAD SIZE	QTY
05HZCVM10	50	8	M10	100

FEMALE DRILLCUTTA



PART N°	QF	LENGTH (mm)	HOLE SIZE (mm)	THREAD SIZE	QTY
05CDC640F10	F0389	40	6	M10	100

FBS II SEISMIC ANCHOR ROD HANGER



PART N°	LENGTH (mm)	HOLE SIZE (mm)	THREAD SIZE	QTY
17ZFBS6M10	55	6	M10	50

TSM SEISMIC ANCHOR ROD HANGER



PART N°	LENGTH (mm)	HOLE SIZE (mm)	THREAD SIZE	QTY
17ZTSM10	55	6	M10	50
17ZTSM10-40	40	6	M10	50

MALE DRILLCUTTA



PART N°	QF	LENGTH (mm)	HOLE SIZE (mm)	THREAD SIZE	QTY
05CDC640M10	F0391	40	6	M10	100

DRILLCUTTA - BUCKET



PART N°	DESCRIPTION	LENGTH (mm)	HOLE SIZE (mm)	SIZE	QTY
05CDC640F10-BKT	FEMALE BUCKET (1 SLEEVE ADAPTER, 1 SDS DRILL BIT, 1 DRIVER SOCKET)	40	6	M10	500
05CDC640M10-BKT	FEMALE BUCKET (1 SLEEVE ADAPTER, 1 SDS DRILL BIT, 1 DRIVER SOCKET)	40	6	M10	250
057197	FEMALE DRIVER SOCKET	-	-	1/2 INCH	1
05CDCD	MALE DRIVER SOCKET	-	-	13MM	1
055865	SLEEVE ADAPTER	-	-	-	1
24SDC06170	SDS DRILL BIT	170	-	6MM	1



CONCRETE INSERTS

WOOD-KNOCKER

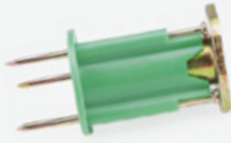

PART N°	QF	THREAD SIZE	QTY
02WKMM10	F0139	M10	100
02WKMM12	F0140	M12	100

BANG-IT



PART N°	QF	THREAD SIZE	QTY
02BBHM1012	-	M6 M10 M12	100
02BIMDI10	F0113	M10	100
02BIMDI12	-	M12	100

SLEEVE ANCHORS

HEX SLEEVE ANCHOR - ZINC



Galvanised also available.

PART N°	QF	LENGTH (mm)	FINISH	FASTENS (mm)	HOLE SIZE (mm)	MIN. EMBED DEPTH (mm)	QTY
01HS6520	F0098	20	ZINC	2	6.5	18	100
01HS6525	F0099	25	ZINC	5	6.5	20	100
01HS6535	F0100	35	ZINC	5	6.5	30	100
01HS6555	F0102	55	ZINC	25	6.5	30	100
01HS6575	F0103	75	ZINC	45	6.5	30	100
01HS0840	F0055	40	ZINC	5	8	35	100
01HS0865	F0058	65	ZINC	30	8	35	50
01HS1040	F0065	40	ZINC	5	10	35	50
01HS1050	F0067	50	ZINC	10	10	40	50
01HS1060	F0070	60	ZINC	20	10	40	50
01HS1075	F0073	75	ZINC	35	10	40	50
01HS1095	F0076	95	ZINC	55	10	40	50
01HS1260	F0084	60	ZINC	10	12	50	50
01HS1275	F0087	75	ZINC	25	12	50	25
01HS12100	F0079	100	ZINC	50	12	50	25
01HS12130	F0082	130	ZINC	80	12	50	25
01HS1665	F0093	65	ZINC	10	16	55	25
01HS16110	F0090	110	ZINC	55	16	55	10
01HS2075	F0097	75	ZINC	15	20	60	10
01HS20105	F0095	105	ZINC	45	20	60	10
01HS20150	F0096	150	ZINC	90	20	60	10

EYE BOLT ANCHOR



PART N°	QF	LENGTH (mm)	HOLE SIZE (mm)	MIN. EMBED DEPTH (mm)	QTY
01EB8045	F0033	45	8	45	100



HEX SLEEVE ANCHOR - STAINLESS STEEL



PART N°	QF	LENGTH (mm)	FINISH	FASTENS (mm)	HOLE SIZE (mm)	MIN. EMBED DEPTH (mm)	QTY
01HS0840SS	F0057	40	S/S	5	8	35	100
01HS1050SS	F0069	50	S/S	10	10	40	50
01HS1060SS	F0072	60	S/S	20	10	40	50
01HS1075SS	F0075	75	S/S	35	10	40	50
01HS1095SS	F0078	95	S/S	55	10	40	50
01HS1260SS	F0086	60	S/S	10	12	50	50
01HS1275SS	F0089	75	S/S	25	12	50	25

HEX SLEEVE ANCHOR - GALVANISED



PART N°	QF	LENGTH (mm)	FINISH	FASTENS (mm)	HOLE SIZE (mm)	MIN. EMBED DEPTH (mm)	QTY
01HS0840G	F0056	40	GAL	5	8	35	100
01HS0865G	F0059	65	GAL	30	8	35	50
01HS1040G	F0066	40	GAL	5	10	35	50
01HS1050G	F0068	50	GAL	10	10	40	50
01HS1060G	F0071	60	GAL	20	10	40	50
01HS1075G	F0074	75	GAL	35	10	40	50
01HS1095G	F0077	95	GAL	55	10	40	50
01HS1260G	F0085	60	GAL	10	12	50	50
01HS1275G	F0088	75	GAL	25	12	50	25
01HS12100G	F0080	100	GAL	50	12	50	25
01HS12130G	F0083	130	GAL	80	12	50	25
01HS1665G	F0094	65	GAL	10	16	55	25

SUSPENSION ANCHORS

TIE WIRE POINT



PART N°	QF	LENGTH (mm)	HOLE SIZE (mm)	MIN. EMBED DEPTH (mm)	QTY
05TW3700	F0433	32	5	32	100
05LTW505085	F0404	85	5	32	100
05TW3759	F0434	32	6.5	32	100

NAIL EYELET ANCHOR



PART N°	LENGTH (mm)	HOLE SIZE (mm)	MIN. EMBED DEPTH (mm)	QTY
17HF-FNA625	54	6	35	50

TIE WIRE ANCHOR



PART N°	QF	LENGTH (mm)	FINISH	HOLE SIZE (mm)	MIN. EMBED DEPTH (mm)	QTY
01TW06120TB	F0110	120	ZINC	6	40	50
01TW6560TB	F0111	60	ZINC	6.5	40	100



THROUGH BOLTS

THROUGH BOLT C1 - ZINC



PART N°	LENGTH (mm)	FINISH	SOCKET SIZE	HOLE SIZE (mm)	MIN. EMBED DEPTH (mm)	QTY
03PTB69294	85	ZINC	10	6	41	100
03PTB69308	85	ZINC	13	8	48	100
03PTB69334	90	ZINC	17	10	71	50
03PTB69358	90	ZINC	19	12	71	50
03PTB69360	100	ZINC	19	12	71	50
03PTB69366	135	ZINC	19	12	71	25
03PTB69372	185	ZINC	19	12	71	25
03PTB69388	115	ZINC	24	16	95	25
03PTB69390	125	ZINC	24	16	95	20

THROUGH BOLT - GALVANISED



PART N°	QF	LENGTH (mm)	FINISH	FASTENS (mm)	HOLE SIZE (mm)	MIN. EMBED DEPTH (mm)	QTY
03PTB10090G	F0265	90	GAL	17	10	60	25
03PTB10120G	F0266	120	GAL	47	10	60	25
03PTB12080G	F0267	80	GAL	5	12	60	25
03PTB12100G	F0268	100	GAL	25	12	60	25
03PTB12140G	F0270	140	GAL	45	12	80	25
03PTB16105G	F0271	105	GAL	5	16	80	25
03PTB16140G	F0273	140	GAL	20	16	100	25
03PTB16190G	F0274	190	GAL	70	16	100	25
03PTB20125G	F0275	125	GAL	5	20	100	10
03PTB20160G	F0276	160	GAL	20	20	120	10
03PTB20200G	F0277	200	GAL	60	20	120	10

SEISMIC RATED THROUGH BOLTS

SEISMIC RATED THROUGH BOLT C1 & C2 - ZINC

PLEASE NOTE:
C2 rating applies for
M10, M12 and M16.



PART N°	LENGTH (mm)	FINISH	SOCKET SIZE	HOLE SIZE (mm)	MIN. EMBED DEPTH (mm)	QTY
03FAZ0875	75	ZINC	13	8	65	50
03FAZ1095	95	ZINC	17	10	85	50
03FAZ12110	110	ZINC	19	12	100	20
03FAZ16148	148	ZINC	24	16	135	10



SCREW BOLTS

HEX SCREW BOLT - ZINC



PART N°	QF	LENGTH (mm)	FINISH	FASTENS (mm)	HOLE SIZE (mm)	MIN. EMBED DEPTH (mm)	QTY
03BT550	F0163	50	ZINC	25	5	25	100
03BT630	F0166	30	ZINC	5	6	25	100
03BT650	F0167	50	ZINC	25	6	25	100
03BT6575	F0169	75	ZINC	50	6	25	50
03BT8100	F0171	100	ZINC	65	8	35	50
03BT850	F0173	50	ZINC	15	8	35	50
03BT875	F0175	75	ZINC	40	8	35	50
03BT10100	F0146	100	ZINC	60	10	40	50
03BT10120	F0148	120	ZINC	80	10	40	50
03BT1060	F0150	60	ZINC	20	10	40	50
03BT1075	F0153	75	ZINC	35	10	40	50
03BT12100	F0155	100	ZINC	50	12	50	50
03BT12150	F0157	150	ZINC	100	12	50	25
03BT1275	F0159	75	ZINC	25	12	50	50
03BT16100	F0161	100	ZINC	35	16	65	15

HEX SCREW BOLT - GALVANISED



PART N°	LENGTH (mm)	FINISH	HOLE SIZE (mm)	QTY
03BT550G	50	GALV	5	100
03BT630G	30	GALV	6	100
03BT650G	50	GALV	6	100
03BT675G	75	GALV	6	50
03BT850G	50	GALV	8	50
03BT860G	60	GALV	8	50
03BT875G	75	GALV	8	50
03BT8100G	100	GALV	8	50
03BT1075G	75	GALV	10	50
03BT10100G	100	GALV	10	50
03BT10120G	120	GALV	10	50
03BT1275G	75	GALV	12	50
03BT12100G	100	GALV	12	50
03BT12150G	150	GALV	12	50
03BT16100G	100	GALV	16	50
03BT16150G	150	GALV	16	50



SEISMIC RATED CONCRETE SCREW BOLTS

SEISMIC HEX SCREW BOLT - ZINC



PART N°	LENGTH (mm)	SOCKET SIZE (mm)	HOLE SIZE (mm)	NOMINAL EMBED DEPTH (mm)	QTY
03PBT635	35	10	6	30	100
03PBT650	50	10	6	40	100
03PBT680	80	10	6	40	50
03PBT6100	100	10	6	40	50
03PBT855	55	13	8	50	50
03PBT1060	60	17	10	55	50

SEISMIC HEX SCREW BOLT - GALVANISED



PART N°	LENGTH (mm)	SOCKET SIZE (mm)	HOLE SIZE (mm)	NOMINAL EMBED DEPTH (mm)	QTY
03PBT680G	80	10	6	40	50
03PBT1060G	60	17	10	55	50
03PBT1080G	80	17	10	60	25

CHEMICAL ANCHORS

CHEM CAP STUD - ZINC



PART N°	QF	LENGTH (mm)	FINISH	FASTENS (mm)	THREAD SIZE	QTY
03STM10130	F0237	130	ZINC	28	M10	10
03STM12160	F0239	160	ZINC	36	M12	10
03STM16190	F0241	190	ZINC	42	M16	10
03STM20260	F0243	260	ZINC	72	M20	5

CHEM CAP STUD - GALVANISED



PART N°	QF	LENGTH (mm)	FINISH	FASTENS (mm)	THREAD SIZE	QTY
03STM8110G	F0248	110	GAL	17	M8	10
03STM10130G	F0238	130	GAL	28	M10	10
03STM12160G	F0240	160	GAL	36	M12	10
03STM16190G	F0242	190	GAL	42	M16	10
03STM20260G	F0244	260	GAL	72	M20	5

AC100E



* Refer page 166 for Caulking Gun

PART N°	QF	QTY
03AC100E	F0144	10

PURE 150 PRO



* Refer page 144 for Caulking Gun

PART N°	QF	QTY
03PFPRO585	F0228	10

PV45 PRO



* Refer page 144 for Caulking Gun

PART N°	PART N°	QTY
03KF2	F0232	10



PLASTIC SIEVE



PART N°	QF	LENGTH (mm)	TO SUIT	HOLE SIZE (mm)	QTY
03PSM850	F0231	50	M8	12	10
03PSM101285	F0229	85	M10	16	10
03PSM1685	F0230	85	M12/M16	20	10

CHEMSET MIXER NOZZLE



PART N°	QF	QTY
03MKNK	F0207	1

MASONRY PLUGS

MUNGO MN NYLON PLUG



PART N°	SIZE (mm)	DRILL DIAMETER (mm)	SCREW DIAMETER (mm)	QTY
06MN525	5 x 25	5	2.6 - 4	100
06MN630	6 x 30	6	3.5 - 5	100
06MN840	8 x 40	8	4.5 - 6	100
06MN1050	10 x 50	10	6 - 8	50
06MN1260	12 x 60	12	8 - 10	25
06MN1470	14 x 70	14	10 - 12	20

MUNGO MNA NYLON PLUG WITH SCREW DRIVE



PART N°	SIZE (mm)	DRILL DIAMETER (mm)	QTY
06MNA530	5 x 30	5	100
06MNA635	6 x 35	6	100
06MNA650	6 x 50	6	100
06MNA860	8 x 60	8	100
06MNA8100	8 x 100	8	100
06MNA8120	8 x 120	8	100

METAL PIN ANCHORS

FIRE RATED WEDGE ANCHOR



PART N°	QF	LENGTH (mm)	HOLE SIZE (mm)	FASTENS (mm)	MIN. EMBED DEPTH (mm)	QTY
06PBZ0635FR	F0475	35	6	5	30	200

METAL PIN ANCHOR



PART N°	QF	LENGTH (mm)	HOLE SIZE (mm)	FASTENS (mm)	QTY
06MPA0522	F0468	22	5	6.5	100
06MPA6525	F0469	25	6.5	10	100
06MPA6532	F0470	32	6.5	13	100
06MPA6538	F0471	38	6.5	22	100
06MPA6550	F0472	50	6.5	28	100

SPIKES

MUSHROOM HEAD SPIKE



PART N°	QF	LENGTH (mm)	HOLE SIZE (mm)	FASTENS (mm)	QTY
05MH53MM	F0415	25	5	3	100
05MH510MM	F0410	32	5	10	100
05MH516MM	F0412	38	5	16	100
05MH519MM	F0413	50	5	19	100
05MH653MM	F0418	25	6.5	3	100
05MH656MM	F0422	38	6.5	6	100
05MH6519MM	F0416	50	6.5	19	100
05MH6532MM	F0417	63	6.5	32	100
05MH6544MM	F0419	75	6.5	44	100
05MH6568MM	F0421	102	6.5	68	100

WALL DOGS

WALL DOG



PART N°	QF	LENGTH (mm)	TO SUIT	FINISH	HOLE SIZE (mm)	QTY
07WDOG	F0536	32	PH2 Drive	ZINC	5	100
07WDOG32	F0537	32	SQ2 Drive	ZINC	5	100
07WDOG50	F0538	50	SQ2 Drive	ZINC	5	100



CAVITY FIXINGS

The Acura MSL Anchor is a highly unique German-made anchor used for fastening into challenging base materials where no others can. Perfect for fragile/hollow applications, MSL Anchors installation, eliminating the need of chemical fastening. The anchor also features a self-indicating torque mechanism to ensure its effectiveness & security.

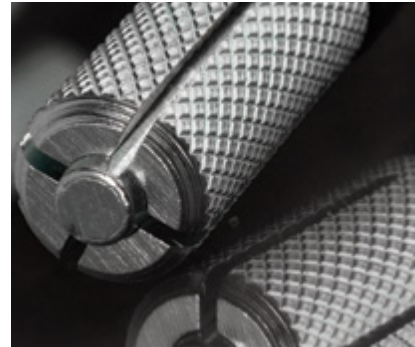

MSL ANCHOR



PART N°	QF	LENGTH (mm)	HOLE SIZE (mm)	FASTENS (mm)	QTY
04MSLH1260	F0341	60	12	10	25
04MSLH1280	F0342	80	12	30	25
04MSLH12100	F0337	100	12	50	25
04MSLH12120	F0338	120	12	70	25
04MSLH12140	F0339	140	12	90	25
04MSLH12160	F0340	160	12	110	25

MKD METAL CLAW ANCHOR



PART N°	QF	LENGTH (mm)	HOLE SIZE (mm)	QTY
04MKD632	F0323	32	32	100
04MKD838	F0324	38	38	100
04MKD860	F0325	60	60	100
04MKD1060	F0322	60	60	100

PLASTIC PLUGS

PVC WALL PLUGS



PART N°	QF	LENGTH (mm)	HOLE SIZE (mm)	SCREW GAUGE	QTY
06W25	F0492	25	5	6	1000
06R25	F0476	25	6	7-8	1000
06R30	F0477	20	6	7-8	1000
06R38	F0478	38	6	7-8	1000
06R50	F0479	50	6	7-8	1000
06G25	F0451	25	6.5	10-12	1000
06G30	F0452	30	6.5	10-12	1000
06G38	F0453	38	6.5	10-12	500
06G50	F0454	50	6.5	10-12	500
06B38	F0437	38	8	14	500
06B50	F0438	50	8	14	500
06O35	F0473	38	10	5/16in	500
06O50	F0474	50	10	5/16in	400



NYLON ANCHORS

ROUND HEAD NYLON ANCHOR



PART N°	QF	LENGTH (mm)	HOLE SIZE (mm)	FASTENS (mm)	QTY
06RN0525	F0480	25	5	6.5	100
06RN0540	F0482	40	5	19	100
06RN6525	F0483	25	6.5	6.5	100
06RN6538	F0485	38	6.5	19	100
06RN6550	F0487	50	6.5	32	100
06RN6575	F0488	75	6.5	50	100

MUSHROOM HEAD NYLON ANCHOR



PART N°	QF	LENGTH (mm)	HOLE SIZE (mm)	FASTENS (mm)	QTY
06MN0525	F0459	25	5	6.5	100
06MN0540	F0461	40	5	19	100
06MN6525	F0463	25	6.5	6.5	100
06MN6538	F0465	38	6.5	19	100
06MN6550	F0466	50	6.5	32	100
06MN6575	F0467	75	6.5	50	50
06MN65100	F0462	100	6.5	75	50

ROUND HEAD NYLON ANCHOR STAINLESS STEEL



PART N°	QF	LENGTH (mm)	HOLE SIZE (mm)	FASTENS (mm)	QTY
06RN0525SS	F0481	25	5	6.5	100
06RN6525SS	F0484	25	6.5	6.5	100

MUSHROOM HEAD NYLON ANCHOR STAINLESS STEEL



PART N°	QF	LENGTH (mm)	HOLE SIZE (mm)	FASTENS (mm)	QTY
06MN0525SS	F0460	25	5	6.5	100
06MN6525SS	F0464	25	6.5	6.5	100

GAS FIXINGS

COBRA PINS AND FUEL CELL



PART N°	QF	SIZE (mm)	TO SUIT	QTY
0830516	F0541	16	DXG3000	1000
0830522	F0542	22	DXG3000	1000

COBRA V PINS AND FUEL CELL



PART N°	QF	SIZE (mm)	TO SUIT	QTY
0855318HC	F0591	18	COBRA V	800
0855322HC	F0594	22	COBRA V	800

COBRA FUEL CELL



* Refer page 146 for Gas Tools.

PART N°	QF	TO SUIT	QTY
0855010	F0566	DXG3000	1

COBRA V FUEL CELL



* Refer page 146 for Gas Tools.

PART N°	QF	TO SUIT	QTY
0855301	F0589	COBRA V	1



COBRA CONTRACTOR PACK



PART N°	QF	SIZE (mm)	TO SUIT	QTY
08DXG3CP	F0649	22	DXG3000	1000

COBRA V CONTRACTOR PACK



PART N°	QF	SIZE (mm)	TO SUIT	QTY
085532ZCP	F0593	22	COBRA V	800

COBRA ZIP CONTRACTOR PACK



PART N°	QF	SIZE (mm)	TO SUIT	QTY
08DXG3ZCP	F2153	22	DXG3000	1000

COBRA V ZIP CONTRACTOR PACK



PART N°	QF	SIZE (mm)	TO SUIT	QTY
085532ZCP	F2152	22	COBRA V	800

COBRA ZIP CABLE TIE



PART N°	QF	TO SUIT	QTY
0855074Z	F0580	DXG3000/COBRA V	100

COBRA MOUNT



PART N°	QF	TO SUIT	QTY
0855074	F0579	DXG3000/COBRA V	100

COBRA M10 HANGER



PART N°	QF	TO SUIT	QTY
08DXG3M10HA	F0651	DXG3000	100

QUICK CHANNEL



PART N°	QF	FINISH	LENGTH (mm)	QTY
0855452	F0608	ZINC	2000	20
0855452-PVC	F0656	PVC	1000	20

QUICK CLIP



PART N°	QF	SIZE (mm)	QTY
0855400	F0601	12-13	100
0855402	F0602	14-18	100
0855404	F0603	20-25	50
0855406	F0605	26-32	50
0855408	F0606	35-42	25
0855410	F0607	47-50	50

PLASTIC HALF SADDLE



PART N°	QF	SIZE (mm)	QTY
0855340	F0598	16	100
0855350	F0599	20	100
0855360	F0600	25	100



PA FIXINGS

PA ANGLE CLIP



PART N°	QF	SIZE (mm)	QTY
08DP27AC	F0625	27	100
08DP32AC	F0626	32	100

PA CABLE TIE



PART N°	QF	LENGTH (mm)	QTY
08DPCTHD	F0641	200	100

PA WASHERED DRIVE PIN



PART N°	QF	SIZE (mm)	QTY
08DP827W	F0635	27	100
08DP832W	F0636	32	100

PA CHARGE STRIPS



PART N°	QF	COLOUR	QTY
0850622G	F0562	GREEN	100
0850626Y	F0563	YELLOW	100
0850630R	F0564	RED	100

PA M10 HANGER



PART N°	QF	THREAD SIZE	QTY
08DPM10HA	F0644	M10	50

PLASTERBOARD FIXINGS

HOLLOW WALL ANCHOR



PART N°	QF	HOLE SIZE (mm)	THREAD SIZE	WALL THICKNESS	QTY
07HWA4XS	F0513	8	1/8in	4-5	100
07HWA4SL	F0511	8	1/8in	3-16	100
07HWA4S	F0509	8	1/8in	10-12	100
07HWA4L	F0508	8	1/8in	16-24	100
07HWA4XL	F0512	8	1/8in	25-32	100
07HWA6S	F0515	10	3/16in	10-16	50
07HWA8S	F0516	11	1/4in	10-12	50

* Refer page 144 for Setting Tool.



The hollow wall anchor is an excellent fixing for higher loads in plasterboard walls and ceilings. Supplied with a crossed pan head screw.

Use the setting tool to make light work of the installation of this superior fixing.

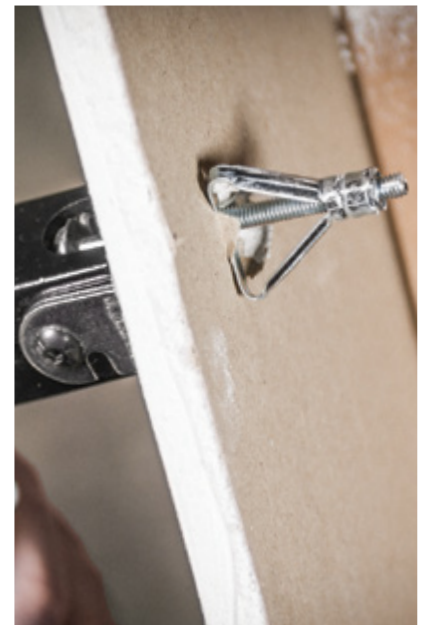



HOOK SPRING TOGGLE



PART N°	QF	HOLE SIZE (mm)	THREAD SIZE	WALL THICKNESS (mm)	QTY
07STCH3163	F0534	6-10	3/16in	54	100

SPRING TOGGLE



PART N°	QF	HOLE SIZE (mm)	THREAD SIZE	WALL THICKNESS (mm)	QTY
07ST182	F0528	10	1/8in	30	50
07ST183	F0529	10	1/8in	50	50
07ST3162	F0530	13	3/16in	24	50
07ST3163	F0531	13	3/16in	50	50
07ST3164	F0532	13	3/16in	74	50
07ST143	F0527	20	1/4in	50	50

HEAVY DUTY TOGGLE



PART N°	QF	LENGTH (mm)	HOLE SIZE (mm)	THREAD SIZE	QTY
04DV8100	F0303	100	22	M8	100
04DV8200	F0304	200	22	M8	50
04DV10100	F0301	100	25	M10	100
04DV10200	F0302	200	25	M10	50

PLASTER PLUG - METAL



PART N°	QF	SCREW GAUGE	QTY
07PMZN	F0519	6-10	100

PLASTER PLUG - NYLON



PART N°	QF	SCREW GAUGE	QTY
07PMNY	F0518	6-10	100

POLY TOGGLE



PART N°	QF	HOLE SIZE (mm)	SCREW GAUGE	WALL THICKNESS (mm)	QTY
07PT10	F0520	8	6-12	10-13	100

SCORPION PLUG



PART N°	QF	SCREW GAUGE	QTY
07SCORP	F0525	7	100

INSULATION FIXINGS

A-ISOL INSULATION FIXING



PART N°	QF	SIZE (mm)	QTY
04A-ISOL50	F0295	50	50
04A-ISOL85	F0296	85	50
04A-ISOL120	F0293	120	50
04A-ISOL155	F0294	155	50



CABLE TIES

Ball lock stainless steel cable ties consist of a non-releasable locking mechanism that offers infinite adjustment along the length of the tie. Suitable for use where additional strength, fire resistance and chemical resistance is required.

CABLE TIE - STAINLESS STEEL



* Refer page 168 for Cable Tie Tensioners.

PART N°	QF	LENGTH (mm)	SIZE (mm)	QTY
36CT20046SS	I1304	200	4.6	100
36CT36079SS	I1309	360	7.9	100
36CT52046SS	I1312	520	4.6	100
36CT52012SS	I1311	520	12	100
36CT84045SS	I1317	840	4.6	100
36CT84012SS	I1316	840	12	100
36CT100046SS	I1298	1000	4.6	100

BOLTS

CUP HEAD BOLT AND NUT



PART N°	QF	LENGTH (mm)	FINISH	THREAD SIZE	QTY
12CB6020	F1234	20	ZINC	M6	200
12CB6025	F1235	25	ZINC	M6	200
12CB6030	F1236	30	ZINC	M6	200
12CB6040	F1238	40	ZINC	M6	200
12CB6050	F1239	50	ZINC	M6	200
12CB8025	F1246	25	ZINC	M8	200
12CB8030	F1248	30	ZINC	M8	200
12CB8040	F1250	40	ZINC	M8	200
12CB8050	F1252	50	ZINC	M8	150
12CB8065	F1253	65	ZINC	M8	150
12CB1025	F1264	25	ZINC	M10	200
12CB1030	F1266	30	ZINC	M10	200
12CB1040	F1268	40	ZINC	M10	150
12CB1050	F1270	50	ZINC	M10	100
12CB1065	F1273	65	ZINC	M10	100
12CB1075	F1276	75	ZINC	M10	100
12CB1250	F1302	50	ZINC	M12	150
12CB1275	F1306	75	ZINC	M12	150

CABLE TIE



* Refer page 168 for Cable Tie Tensioners.

PART N°	QF	LENGTH (mm)	SIZE (mm)	QTY
36CT20046	I1302	200	4.6	100
36CT20076	I1305	200	7	100
36CT28046	I1306	280	4.6	100
36CT30076	I1308	300	7.6	100
36CT37076	I1310	370	7.6	100
36CT53080	I1313	550	9	100
36CT83090	I1315	920	9	100
36CT122090	I1299	1210	9	100
36CT135090	I1300	1350	9	100
36CT155090	I1301	1550	9	100



HEX BOLT AND NUT - ZINC



PART N°	QF	LENGTH (mm)	FINISH	THREAD SIZE	QTY
12HBM06020	F1365	20	ZINC	M6	200
12HBM06025	F1369	25	ZINC	M6	200
12HBM06030	F1373	30	ZINC	M6	200
12HBM06040	F1376	40	ZINC	M6	200
12HBM06050	F1379	50	ZINC	M6	200
12HBM06075	F1381	75	ZINC	M6	150
12HBM08020	F1384	20	ZINC	M8	200
12HBM08025	F1387	25	ZINC	M8	200
12HBM08030	F1391	30	ZINC	M8	200
12HBM08035	F1395	35	ZINC	M8	200
12HBM08040	F1398	40	ZINC	M8	200
12HBM08045	F1402	45	ZINC	M8	150
12HBM08050	F1404	50	ZINC	M8	150
12HBM08055	F1408	55	ZINC	M8	150
12HBM08060	F1411	60	ZINC	M8	150
12HBM08065	F1414	65	ZINC	M8	150
12HBM08075	F1417	75	ZINC	M8	100
12HBM08100	F1421	100	ZINC	M8	100
12HBM10020	F1425	20	ZINC	M10	150
12HBM10025	F1429	25	ZINC	M10	150
12HBM10030	F1434	30	ZINC	M10	150
12HBM10035	F1438	35	ZINC	M10	150
12HBM10040	F1442	40	ZINC	M10	150
12HBM10045	F1446	45	ZINC	M10	150
12HBM10050	F1449	50	ZINC	M10	75
12HBM10055	F1453	55	ZINC	M10	75
12HBM10060	F1455	60	ZINC	M10	75
12HBM10065	F1459	65	ZINC	M10	75
12HBM10070	F1462	70	ZINC	M10	75
12HBM10075	F1465	75	ZINC	M10	75
12HBM10080	F1469	80	ZINC	M10	75
12HBM10090	F1473	90	ZINC	M10	50
12HBM10100	F1475	100	ZINC	M10	50
12HBM10110	F1478	110	ZINC	M10	50
12HBM10120	F1480	120	ZINC	M10	50
12HBM10140	F1484	140	ZINC	M10	50
12HBM12025	F1488	25	ZINC	M12	250
12HBM12030	F1492	30	ZINC	M12	250
12HBM12035	F1496	35	ZINC	M12	200
12HBM12040	F1500	40	ZINC	M12	200
12HBM12045	F1504	45	ZINC	M12	175
12HBM12050	F1508	50	ZINC	M12	175
12HBM12055	F1512	55	ZINC	M12	150
12HBM12060	F1515	60	ZINC	M12	150
12HBM12065	F1519	65	ZINC	M12	150
12HBM12070	F1523	70	ZINC	M12	150

PART N°	QF	LENGTH (mm)	FINISH	THREAD SIZE	QTY
12HBM12075	F1527	75	ZINC	M12	150
12HBM12100	F1535	100	ZINC	M12	100
12HBM12120	F1540	120	ZINC	M12	100
12HBM16025	F1553	25	ZINC	M16	125
12HBM16030	F1556	30	ZINC	M16	100
12HBM16035	F1559	35	ZINC	M16	100
12HBM16040	F1562	40	ZINC	M16	100
12HBM16045	F1565	45	ZINC	M16	100
12HBM16050	F1568	50	ZINC	M16	100
12HBM16055	F1572	55	ZINC	M16	75
12HBM16060	F1575	60	ZINC	M16	75
12HBM16065	F1579	65	ZINC	M16	75
12HBM16070	F1583	70	ZINC	M16	75
12HBM16075	F1586	75	ZINC	M16	75
12HBM16080	F1590	80	ZINC	M16	75
12HBM16085	F1594	85	ZINC	M16	75
12HBM16090	F1596	90	ZINC	M16	75
12HBM16100	F1600	100	ZINC	M16	50
12HBM16110	F1604	110	ZINC	M16	50
12HBM16120	F1607	120	ZINC	M16	50
12HBM16130	F1610	130	ZINC	M16	50
12HBM16140	F1614	140	ZINC	M16	40
12HBM16150	F1617	150	ZINC	M16	40
12HBM2035	F1628	35	ZINC	M20	50
12HBM2040	F1629	40	ZINC	M20	50
12HBM2045	F1632	45	ZINC	M20	50
12HBM2050	F1635	50	ZINC	M20	50
12HBM2055	F1638	55	ZINC	M20	50
12HBM2060	F1640	60	ZINC	M20	50
12HBM2065	F1643	65	ZINC	M20	50
12HBM2070	F1646	70	ZINC	M20	50
12HBM2075	F1648	75	ZINC	M20	50
12HBM2080	F1651	80	ZINC	M20	50
12HBM2090	F1656	90	ZINC	M20	30
12HBM20100	F1659	100	ZINC	M20	30
12HBM20110	F1663	110	ZINC	M20	30
12HBM20120	F1665	120	ZINC	M20	30
12HBM20130	F1668	130	ZINC	M20	30
12HBM20140	F1671	140	ZINC	M20	25
12HBM20150	F1674	150	ZINC	M20	25

NYLON BOLT



PART N°	LENGTH (mm)	FINISH	THREAD SIZE	QTY
12HBM08025NN	25	NYLON	M8	50
12HBM08030NN	30	NYLON	M8	50
12HBM08050NN	50	NYLON	M8	50
12HBM10025NN	25	NYLON	M10	25
12HBM10030NN	30	NYLON	M10	25
12HBM10050NN	50	NYLON	M10	25



HEX BOLT AND NUT - GALVANISED



PART N°	QF	LENGTH (mm)	FINISH	THREAD SIZE	QTY
12HBM06020G	F1367	20	HDG	M6	200
12HBM06025G	F1371	25	HDG	M6	200
12HBM06030G	F1374	30	HDG	M6	200
12HBM06040G	F1377	40	HDG	M6	200
12HBM06050G	F1380	50	HDG	M6	200
12HBM08025G	F1389	25	HDG	M8	200
12HBM08030G	F1393	30	HDG	M8	200
12HBM08035G	F1396	35	HDG	M8	200
12HBM08040G	F1400	40	HDG	M8	200
12HBM08050G	F1406	50	HDG	M8	150
12HBM08055G	F1409	55	HDG	M8	150
12HBM08060G	F1413	60	HDG	M8	150
12HBM08065G	F1416	65	HDG	M8	150
12HBM08075G	F1419	75	HDG	M8	100
12HBM10020G	F1427	20	HDG	M10	150
12HBM10025G	F1431	25	HDG	M10	150
12HBM10030G	F1436	30	HDG	M10	150
12HBM10035G	F1440	35	HDG	M10	150
12HBM10040G	F1444	40	HDG	M10	150
12HBM10045G	F1448	45	HDG	M10	150
12HBM10050G	F1451	50	HDG	M10	75
12HBM10055G	F1454	55	HDG	M10	75
12HBM10060G	F1457	60	HDG	M10	75
12HBM10065G	F1461	65	HDG	M10	75
12HBM10070G	F1464	70	HDG	M10	75
12HBM10075G	F1467	75	HDG	M10	75
12HBM10080G	F1471	80	HDG	M10	75
12HBM10100G	F1477	100	HDG	M10	50
12HBM10110G	F1479	110	HDG	M10	50
12HBM10120G	F1482	120	HDG	M10	50
12HBM10140G	F1485	140	HDG	M10	50
12HBM12025G	F1490	25	HDG	M12	250
12HBM12030G	F1494	30	HDG	M12	250
12HBM12035G	F1498	5	HDG	M12	200
12HBM12040G	F1502	40	HDG	M12	200
12HBM12045G	F1506	45	HDG	M12	175
12HBM12050G	F1510	50	HDG	M12	175
12HBM12055G	F1513	55	HDG	M12	150
12HBM12060G	F1517	60	HDG	M12	150
12HBM12065G	F1521	65	HDG	M12	150
12HBM12070G	F1525	70	HDG	M12	150
12HBM12075G	F1529	75	HDG	M12	150
12HBM12100G	F1537	100	HDG	M12	100

PART N°	QF	LENGTH (mm)	FINISH	THREAD SIZE	QTY
12HBM12120G	F1542	120	HDG	M12	100
12HBM12130G	F1545	130	HDG	M12	100
12HBM16025G	F1554	25	HDG	M16	125
12HBM16030G	F1557	30	HDG	M16	100
12HBM16035G	F1560	35	HDG	M16	100
12HBM16040G	F1563	40	HDG	M16	100
12HBM16045G	F1566	45	HDG	M16	100
12HBM16050G	F1570	50	HDG	M16	100
12HBM16055G	F1573	55	HDG	M16	75
12HBM16060G	F1577	60	HDG	M16	75
12HBM16065G	F1581	65	HDG	M16	75
12HBM16070G	F1584	70	HDG	M16	75
12HBM16075G	F1588	75	HDG	M16	75
12HBM16080G	F1592	80	HDG	M16	75
12HBM16085G	F1595	85	HDG	M16	75
12HBM16090G	F1598	90	HDG	M16	75
12HBM16100G	F1602	100	HDG	M16	50
12HBM16110G	F1605	110	HDG	M16	50
12HBM16120G	F1608	120	HDG	M16	50
12HBM16130G	F1612	130	HDG	M16	50
12HBM16140G	F1615	140	HDG	M16	40
12HBM16150G	F1618	150	HDG	M16	40
12HBM16160G	F1620	160	HDG	M16	40
12HBM16170G	F1621	170	HDG	M16	40
12HBM16180G	F1622	180	HDG	M16	30
12HBM16200G	F1623	200	HDG	M16	25
12HBM16240G	F1625	240	HDG	M16	25
12HBM16260G	F1626	260	HDG	M16	25
12HBM16280G	F1627	280	HDG	M16	25
12HBM2040G	F1630	40	HDG	M20	50
12HBM2045G	F1633	45	HDG	M20	50
12HBM2050G	F1636	50	HDG	M20	50
12HBM2055G	F1639	55	HDG	M20	50
12HBM2060G	F1641	60	HDG	M20	50
12HBM2065G	F1644	65	HDG	M20	50
12HBM2070G	F1647	70	HDG	M20	50
12HBM2075G	F1649	75	HDG	M20	50
12HBM2080G	F1652	80	HDG	M20	50
12HBM2085G	F1655	85	HDG	M20	30
12HBM2090G	F1657	90	HDG	M20	30
12HBM20100G	F1661	100	HDG	M20	30
12HBM20110G	F1664	110	HDG	M20	30
12HBM20120G	F1666	120	HDG	M20	30
12HBM20130G	F1669	130	HDG	M20	30
12HBM20140G	F1672	140	HDG	M20	25
12HBM20150G	F1675	150	HDG	M20	25
12HBM20160G	F1676	160	HDG	M20	25
12HBM20170G	F1677	170	HDG	M20	25
12HBM20180G	F1678	180	HDG	M20	25
12HBM20200G	F1679	200	HDG	M20	20
12HBM20220G	F1680	220	HDG	M20	20
12HBM2460G	F1682	60	HDG	M24	25
12HBM24120G	F1693	120	HDG	M24	20



HEX SET SCREW



* Fully Threaded (Bolt Only)

PART N°	QF	LENGTH (mm)	FINISH	THREAD SIZE	QTY
12HSET06010	F1868	10	ZINC	M6	200
12HSET06012	F1869	12	ZINC	M6	200
12HSET06016	F1870	16	ZINC	M6	200
12HSET06020	F1871	20	ZINC	M6	200
12HSET06025	F1872	25	ZINC	M6	200
12HSET06030	F1873	30	ZINC	M6	200
12HSET06040	F1874	40	ZINC	M6	200
12HSET06050	F1875	50	ZINC	M6	200
12HSET06065	F1876	65	ZINC	M6	150
12HSET06075	F1877	75	ZINC	M6	150
12HSET08012	F1878	12	ZINC	M8	200
12HSET08016	F1879	16	ZINC	M8	200
12HSET08020	F1880	20	ZINC	M8	200
12HSET08025	F1881	25	ZINC	M8	200
12HSET08030	F1882	30	ZINC	M8	200
12HSET08035	F1883	35	ZINC	M8	200
12HSET08040	F1884	40	ZINC	M8	200
12HSET08050	F1885	50	ZINC	M8	200
12HSET08065	F1886	65	ZINC	M8	150
12HSET08075	F1887	75	ZINC	M8	150
12HSET08100	F1888	100	ZINC	M8	150
12HSET10012	F1889	12	ZINC	M10	200
12HSET10016	F1890	16	ZINC	M10	150
12HSET10020	F1891	20	ZINC	M10	150
12HSET10025	F1892	25	ZINC	M10	150
12HSET10030	F1893	30	ZINC	M10	150
12HSET10035	F1894	35	ZINC	M10	150
12HSET10040	F1895	40	ZINC	M10	150
12HSET10050	F1896	50	ZINC	M10	75
12HSET10065	F1897	65	ZINC	M10	75
12HSET10075	F1898	75	ZINC	M10	75
12HSET10090	F1899	90	ZINC	M10	50
12HSET10100	F1900	100	ZINC	M10	50
12HSET12020	F1901	20	ZINC	M12	100
12HSET12025	F1903	25	ZINC	M12	100
12HSET12030	F1904	30	ZINC	M12	100
12HSET12035	F1905	35	ZINC	M12	100
12HSET12040	F1906	40	ZINC	M12	100
12HSET12050	F1907	50	ZINC	M12	75
12HSET12060	F1908	60	ZINC	M12	75
12HSET12065	F1909	65	ZINC	M12	75
12HSET12075	F1910	75	ZINC	M12	75
12HSET12090	F1911	90	ZINC	M12	50
12HSET12100	F1912	100	ZINC	M12	50
12HSET12110	F1913	110	ZINC	M12	50
12HSET12130	F1914	130	ZINC	M12	50
12HSET12150	F1915	150	ZINC	M12	50

PART N°	QF	LENGTH (mm)	FINISH	THREAD SIZE	QTY
12HSET16060	F1917	60	ZINC	M16	50
12HSET16075	F1918	75	ZINC	M16	50
12HSET16050	F1916	50	ZINC	M16	50

HEX BOLT - STAINLESS STEEL



* Fully Threaded (Bolt Only)

PART N°	QF	LENGTH (mm)	FINISH	THREAD SIZE	QTY
12HSET06020SS	F1368	20	SS316	M6	100
12HSET06025SS	F1372	25	SS316	M6	100
12HSET06030SS	F1375	30	SS316	M6	100
12HSET08020SS	F1386	20	SS316	M8	100
12HSET08025SS	F1390	25	SS316	M8	100
12HSET08030SS	F1394	30	SS316	M8	100
12HSET08035SS	F1397	35	SS316	M8	100
12HSET08055SS	F1410	55	SS316	M8	50
12HSET10020SS	F1428	20	SS316	M10	100
12HSET10025SS	F1433	25	SS316	M10	100
12HSET10030SS	F1437	30	SS316	M10	100
12HSET10035SS	F1441	35	SS316	M10	100
12HSET10040SS	F1445	40	SS316	M10	100
12HSET10050SS	F1452	50	SS316	M10	100
12HSET10075SS	F1468	75	SS316	M10	50
12HSET12025SS	F1491	25	SS316	M12	100
12HSET12030SS	F1495	30	SS316	M12	50
12HSET12040SS	F1503	40	SS316	M12	50
12HSET12050SS	F1511	50	SS316	M12	50
12HSET12060SS	F1518	60	SS316	M12	25
12HSET12065SS	F1522	65	SS316	M12	25
12HSET12070SS	F1526	70	SS316	M12	25
12HSET12075SS	F1530	75	SS316	M12	25
12HSET12080SS	F1531	80	SS316	M12	25
12HSET16035SS	F1561	35	SS316	M16	25
12HSET16040SS	F1564	40	SS316	M16	25
12HSET16045SS	F1567	45	SS316	M16	25
12HSET16050SS	F1571	50	SS316	M16	25
12HSET16055SS	F1574	55	SS316	M16	25
12HSET16060SS	F1578	60	SS316	M16	25
12HSET16065SS	F1582	65	SS316	M16	25
12HSET16070SS	F1585	70	SS316	M16	25
12HSET16075SS	F1589	75	SS316	M16	25
12HSET16080SS	F1593	80	SS316	M16	25
12HSET16090SS	F1599	90	SS316	M16	25
12HSET16100SS	F1603	100	SS316	M16	25
12HSET16110SS	F1606	110	SS316	M16	25
12HSET16120SS	F1609	120	SS316	M16	25
12HSET16130SS	F1613	130	SS316	M16	20
12HSET16140SS	F1616	140	SS316	M16	20
12HSET16150SS	F1619	150	SS316	M16	20



NUTS

HEX COUPLER



PART N°	QF	FINISH	THREAD SIZE	QTY
12HC6	F1775	ZINC	M6	100
12HC8	F1776	ZINC	M8	100
12HC10	F1777	ZINC	M10	100
12HC12	F1780	ZINC	M12	100
12HC16	F1781	ZINC	M16	50
12HC20	F1783	ZINC	M20	25

FLANGE NUT



PART N°	QF	THREAD SIZE	QTY
12HNM06F	F1797	M6	100
12HNM08F	F1802	M8	100
12HNM10F	F1811	M10	100
12HNM12F	F1821	M12	100
12HNM16F	F1829	M16	100

NYLON NUT



PART N°	QF	FINISH	THREAD SIZE	QTY
12HNM10NN	F1817	NYLON	M10	50

HEX NUT - ZINC



PART N°	QF	FINISH	THREAD SIZE	QTY
12HNM06	F1796	ZINC	M6	100
12HNM08	F1801	ZINC	M8	100
12HNM10	F1807	ZINC	M10	100
12HNM12	F1819	ZINC	M12	100
12HNM16	F1828	ZINC	M16	100
12HNM20	F1834	ZINC	M20	100

HEX NUT - STAINLESS STEEL



PART N°	QF	FINISH	THREAD SIZE	QTY
12HNM06SS	F1799	SS316	M6	100
12HNM08SS	F1806	SS316	M8	100
12HNM10SS	F1818	SS316	M10	100
12HNM12SS	F1826	SS316	M12	100
12HNM16SS	F1833	SS316	M16	100
12HNM20SS	F1837	SS316	M20	100

HEX NUT - GALVANISED



PART N°	QF	FINISH	THREAD SIZE	QTY
12HNM08G	F1803	HDG	M8	100
12HNM10G	F1813	HDG	M10	100
12HNM12G	F1822	HDG	M12	100
12HNM16G	F1830	HDG	M16	100
12HNM20G	F1836	HDG	M20	100
12HNM24G	F1839	HDG	M24	100



NYLOC NUT



PART N°	QF	FINISH	THREAD SIZE	QTY
12HNM06NC	F1798	ZINC	M6	100
12HNM08NC	F1804	ZINC	M8	100
12HNM10NC	F1814	ZINC	M10	100
12HNM12NC	F1823	ZINC	M12	100

WEDGE NUT



PART N°	QF	THREAD SIZE	QTY
12WGNM6	F2050	M6	100
12WGNM8	F2051	M8	100
12WGNM10	F2048	M10	100
12WGNM12	F2049	M10	100

METAL THREADS

METAL THREAD

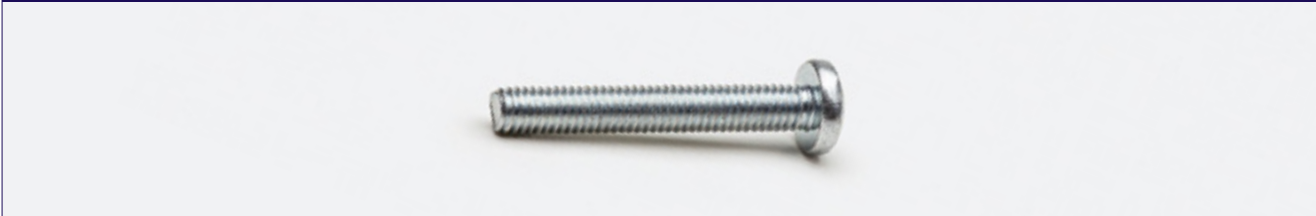

PART N°	QF	LENGTH (mm)	FINISH	THREAD SIZE	QTY
12MTS31612	F1928	1/2in	ZINC	3/16	200
12MTS31634	F1930	3/4in	ZINC	3/16	200
12MTS31610	F1925	1in	ZINC	3/16	200
12MTS316114	F1927	1-1/4in	ZINC	3/16	200
12MTS612	F1936	12	ZINC	M6	200
12MTS620	F1938	20	ZINC	M6	200
12MTS625	F1940	25	ZINC	M6	200
12MTS630	F1942	30	ZINC	M6	200
12MTS640	F1944	40	ZINC	M6	200

HEADLESS SCREWS

HEADLESS SCREWS

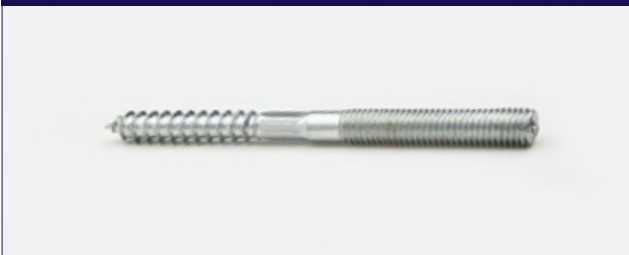

PART N°	QF	LENGTH (mm)	THREAD SIZE	QTY
04ST-RG1080	F0347	80	M10	100
04ST-RG10100	F0345	100	M10	100

TIE WIRES

INTERNAL THREADED TIE WIRE



PART N°	QF	THREAD SIZE	QTY
12TWM10	F1958	M10	50



WASHERS

FLAT WASHER - ZINC



PART N°	QF	TO SUIT	OUTSIDE DIA (mm)	FINISH	QTY
12W06	F1966	M6	16	ZINC	500
12W08	F1975	M8	20	ZINC	200
12W10	F1985	M10	23	ZINC	100
12W12	F2001	M12	27	ZINC	100
12W16	F2016	M16	32	ZINC	100
12W20	F2027	M20	37	ZINC	100

FLAT WASHER - GALVANISED



PART N°	QF	TO SUIT	OUTSIDE DIA (mm)	FINISH	QTY
12W06G	F1968	M6	16	GAL	200
12W08G	F1977	M8	20	GAL	200
12W10G	F1990	M10	23	GAL	200
12W12G	F2005	M12	27	GAL	100
12W16G	F2019	M16	32	GAL	200
12W20G	F2028	M20	37	GAL	100
12W24G	F2033	M24	52	GAL	100

MUDGUARD WASHER



PART N°	QF	TO SUIT	OUTSIDE DIA (mm)	FINISH	QTY
12W06MG	F1970	M6	32	ZINC	200
12W08MG	F1979	M8	32	ZINC	100
12W1050MG	F1986	M10	50	ZINC	100
12W10MG	F1992	M10	32	ZINC	100
12W1250MG	F2002	M12	50	ZINC	100
12W12MG	F2007	M12	37	ZINC	100

SPRING WASHER



PART N°	QF	TO SUIT	FINISH	QTY
12W06SP	F1972	M6	ZINC	200
12W08SP	F1981	M8	ZINC	200
12W10SP	F1994	M10	ZINC	200
12W12SP	F2011	M12	ZINC	200
12W16SP	F2023	M16	ZINC	100
12W20SPG	F2029	M20	ZINC	100

FLAT WASHER - STAINLESS STEEL



PART N°	QF	TO SUIT	OUTSIDE DIA (mm)	FINISH	QTY
12W06SS	F1974	M6	16	SS316	100
12W08SS	F1983	M8	20	SS316	100
12W10SS	F1997	M10	23	SS316	100
12W12SS	F2014	M12	27	SS316	100
12W16SS	F2026	M16	32	SS316	100
12W20SS	F2030	M20	37	SS316	100
12W24SS	F2034	M24	52	SS316	100

NAILS

CLOUTS



PART N°	QF	LENGTH (mm)	SIZE (mm)	QTY
10CLPG2028	F1161	20	2.8	1
10CLPG2528	F1162	25	2.8	1
10CLPG3028	F1163	30	2.8	1

For square washers, please see page 14.



DRILLPOINT SCREWS

BUGLE HEAD DRILLPOINT SCREW



PART N°	QF	LENGTH (mm)	FINISH	SCREW GAUGE	QTY
09BGSD625	F0719	25	ZINC	6	1000
09BGSD632	F0720	32	ZINC	6	1000
09BGSD645	F0721	45	ZINC	6	1000

BUTTON HEAD DRILLPOINT SCREW - CLASS 2



PART N°	QF	LENGTH (mm)	FINISH	SCREW GAUGE	QTY
09BTSD812	F0722	12	ZINC	8	1000
09BTSD816	F0724	16	ZINC	8	1000
09BTSD820	F0726	20	ZINC	8	1000
09BTSD825	F0728	25	ZINC	8	1000
09BTSD832	F0730	32	ZINC	8	1000

BUTTON HEAD DRILLPOINT SCREW - CLASS 3



PART N°	QF	LENGTH (mm)	FINISH	SCREW GAUGE	QTY
09BTSD8123	F0723	12	GAL	8	1000
09BTSD8163	F0725	16	GAL	8	1000
09BTSD8203	F0727	20	GAL	8	1000
09BTSD8253	F0729	25	GAL	8	1000

COUNTERSUNK DRILLPOINT SCREW



PART N°	QF	LENGTH (mm)	FINISH	SCREW GAUGE	QTY
09CSD1030	F0772	30	ZINC	10	1000
09CSD1040	F0773	40	ZINC	10	1000
09CSD1050	F0774	50	ZINC	10	1000
09CSD1065	F0775	65	ZINC	10	1000

FLAT TOP DRILLPOINT SCREW - CLASS 2



PART N°	QF	LENGTH (mm)	FINISH	SCREW GAUGE	QTY
09FTSDZY1016	F0784	16	ZINC	10	1000

FLAT TOP DRILLPOINT SCREW - CLASS 3



PART N°	QF	LENGTH (mm)	FINISH	SCREW GAUGE	QTY
09FTSDC31016	F0782	16	GAL	10	1000
09FTSDC310122	-	22	GAL	10	1000

WAFER HEAD DRILLPOINT SCREW



PART N°	QF	LENGTH (mm)	FINISH	SCREW GAUGE	QTY
09WSD1016	F1111	16	ZINC	10	1000
09WSD1022	F1115	22	ZINC	10	1000
09WSD1022F	F1117	22	ZINC	10 (fine)	1000
09WSD1030	F1120	30	ZINC	10	1000
09WSD1040	F1122	40	ZINC	10	500

WINGED DRILLPOINT SCREW



PART N°	QF	LENGTH (mm)	FINISH	SCREW GAUGE	QTY
09SWSD832	F1054	32	GAL	8	1000
09SWSD1040	F1049	40	GAL	10	1000
09SWSD1045	F1050	45	GAL	10	1000
09SWSD1075	F1052	75	GAL	10	1000



HWF DRILLPOINT SCREW - CLASS 2

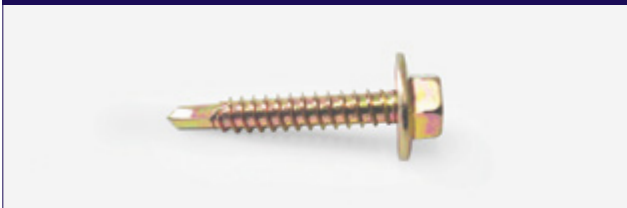

PART N°	QF	LENGTH (mm)	TO SUIT	FINISH	SCREW GAUGE	QTY
09HSDZ812	F0856	12	1/4	ZINC	8	1000
09HSDZ820	F0857	20	1/4	ZINC	8	1000
09HSDZC1016	F0858	16	5/16	ZINC	10	1000
09HSDZF1016	F0860	16	5/16	ZINC	10 (fine)	1000
09HSDZ1025	F0851	25	5/16	ZINC	10	1000
09HSDZC1220	F0859	20	5/16	ZINC	12	1000
09HSDZF1220	F0861	20	5/16	ZINC	12 (fine)	1000
09HSD31235	F0852	35	5/16	ZINC	12	1000
09HSDZ1245	F0853	45	5/16	ZINC	12	1000
09HSDZ1255	F0854	55	5/16	ZINC	12	1000
09HSDZ1265	F0855	65	5/16	ZINC	12	1000

HWF DRILLPOINT SCREW - CLASS 3 NEO



PART N°	QF	LENGTH (mm)	TO SUIT	FINISH	SCREW GAUGE	QTY
09HSD3N101616	F0826	16	5/16	GAL	10	1000
09HSD3N101625	F0828	25	5/16	GAL	10	1000
09HSD3N1235	F0832	35	5/16	GAL	12	1000
09HSD3N1245	F0833	45	5/16	GAL	12	1000
09HSD3N1255	F0837	55	5/16	GAL	12	1000
09HSD3N1265	F0838	65	5/16	GAL	12	1000
09HSD3N1495	F0842	95	3/8	GAL	14	500

SELF EMBEDDING HEAD DRILLPOINT SCREW



PART N°	QF	LENGTH (mm)	FINISH	SCREW GAUGE	QTY
09SESD820	F0906	20	ZINC	8	1000
09SESD830	F0907	30	ZINC	8	1000

HWF DRILLPOINT SCREW - CLASS 3



PART N°	QF	LENGTH (mm)	TO SUIT	FINISH	SCREW GAUGE	QTY
09HSD3101616	F0795	16	5/16	GAL	10	1000
09HSD3102416	F0798	16	5/16	GAL	10 (fine)	1000
09HSD3101625	F0797	25	5/16	GAL	10	1000
09HSD31025	F0799	25	5/16	GAL	10 (fine)	1000
09HSD3121420	F0800	20	5/16	GAL	12	1000
09HSD3122420	F0802	20	5/16	GAL	12 (fine)	1000
09HSD31235	F0804	35	5/16	GAL	12	1000
09HSD31245	F0806	45	5/16	GAL	12	1000
09HSD31265	F0808	65	5/16	GAL	12	1000
09HSD31275	F0809	75	5/16	GAL	12	1000
09HSD3141022	F0810	22	3/8	GAL	14	1000
09HSD3142022	F0815	22	3/8	GAL	14 (fine)	1000
09HSD31425	F0818	25	3/8	GAL	14	500
09HSD31442	F0819	42	3/8	GAL	14	1000
09HSD31450	F0820	50	3/8	GAL	14	1000
09HSD31490	F0824	90	3/8	GAL	14	1000
09HSD314115	F0811	115	3/8	GAL	14	500

HWF DRILLPOINT SERIES 500 SCREW



PART N°	QF	LENGTH (mm)	TO SUIT	FINISH	SCREW GAUGE	QTY
09HSD51232	F0843	32	5/16	GAL	12	1000
09HSD51250	F0845	50	5/16	GAL	12	1000
09HSD51265	F0846	65	5/16	GAL	12	1000

PAN HEAD DRILLPOINT SCREW

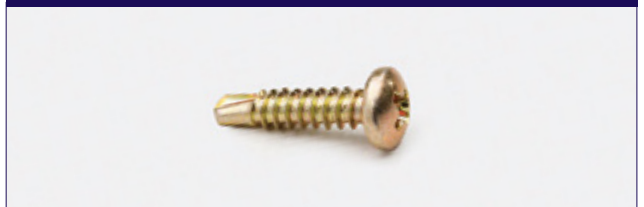

PART N°	QF	LENGTH (mm)	FINISH	SCREW GAUGE	QTY
09PSD812	F0887	12	ZINC	8	1000
09PSD820	F0888	20	ZINC	8	1000



TYPE 17 SCREWS

BUGLE BATTEN SCREW



PART N°	QF	LENGTH (mm)	FINISH	SCREW GAUGE	QTY
09BB1450	F1059	50	GAL	14	1000
09T17B1475	F1061	75	GAL	14	1000
09BB14100	F1055	100	GAL	14	500
09T17B14125	F1056	125	GAL	14	500
09T17B14150	F1057	150	GAL	14	250

HWF TYPE 17 SCREW - CLASS 2



PART N°	QF	LENGTH (mm)	TO SUIT	FINISH	SCREW GAUGE	QTY
09T17HZ1225	F1098	25	5/16	ZINC	12	1000
09T17HZ1235	F1099	35	5/16	ZINC	12	1000
09T17HZ1240	F1100	40	5/16	ZINC	12	1000
09T17HZ1245	F1101	45	5/16	ZINC	12	1000
09T17HZ1250	F1102	50	5/16	ZINC	12	1000
09T17HZ1265	F1103	65	5/16	ZINC	12	1000

HWF TYPE 17 SCREW - CLASS 3 NEO



PART N°	QF	LENGTH (mm)	TO SUIT	FINISH	SCREW GAUGE	QTY
09T17H3N1225	F1090	25	5/16	GAL	12	500
09T17H3N1245	F1091	45	5/16	GAL	12	1000
09T17H3N1250	F1092	50	5/16	GAL	12	1000
09T17H3N1450	F1095	50	3/8	GAL	14	1000
09T17H3N1465	F1096	65	3/8	GAL	14	1000

COUNTERSUNK TYPE 17 SCREW



PART N°	QF	LENGTH (mm)	FINISH	SCREW GAUGE	QTY
09T17C825	F1070	25	ZINC	8	1000
09T17C1030	F1064	30	ZINC	10	1000
09T17C1040	F1065	40	ZINC	10	1000
09T17C1050	F1066	50	ZINC	10	500
09T17C1075	F1067	75	ZINC	10	1000

HWF TYPE 17 SCREW - CLASS 3



PART N°	QF	LENGTH (mm)	TO SUIT	FINISH	SCREW GAUGE	QTY
09T17H31225	F1075	25	5/16	GAL	12	1000
09T17H31235	F1076	35	5/16	GAL	12	1000
09T17H31240	F1077	40	5/16	GAL	12	1000
09T17H31245	F1078	45	5/16	GAL	12	1000
09T17H31250	F1079	50	5/16	GAL	12	1000
09T17H31265	F1080	65	5/16	GAL	12	1000
09T17H31450	F1084	50	3/8	GAL	14	1000
09T17H31465	F1085	65	3/8	GAL	14	1000
09T17H31475	F1086	75	3/8	GAL	14	500
09T17H31490	F1087	90	3/8	GAL	14	500
09T17H314100	F1081	100	3/8	GAL	14	500
09T17H314115	F1082	115	3/8	GAL	14	500
09T17H314150	F1083	150	3/8	GAL	14	500

WAVER HEAD TYPE 17 SCREW

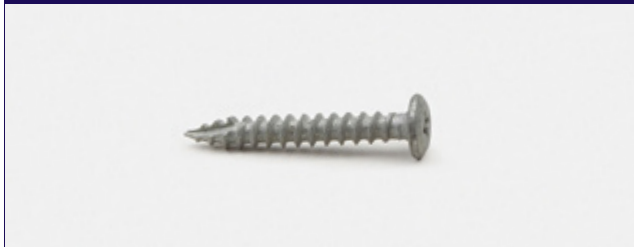

PART N°	QF	LENGTH (mm)	FINISH	SCREW GAUGE	QTY
09T17W31025	F1105	25	GAL	10	1000
09T17W31035	F1106	35	GAL	10	1000
09T17W31045	F1108	45	GAL	10	500



NEEDLEPOINT SCREWS

FLAT TOP NEEDLEPOINT SCREW



PART N°	QF	LENGTH (mm)	FINISH	SCREW GAUGE	QTY
09NPFZY1016	F0868	16	ZINC	10	1000

BUGLE HEAD NEEDLEPOINT SCREW

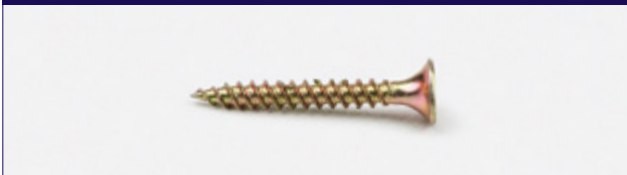

PART N°	QF	LENGTH (mm)	FINISH	SCREW GAUGE	QTY
09GYPB620	F0787	20	ZINC	6	1000
09GYPB625	F0788	25	ZINC	6	1000
09GYPB630	F0789	30	ZINC	6	1000
09GYPB640	F0790	40	ZINC	6	1000
09BE720	F0711	20	ZINC	7	1000
09BE725	F0712	25	ZINC	7	1000
09BE730	F0714	32	ZINC	7	1000
09BE740	F0715	40	ZINC	7	1000
09BE745	F0716	45	ZINC	7	1000
09GYPB750	F0791	50	ZINC	7	1000
09GYPB865	F0792	65	ZINC	8	1000
09GYPB875	F0793	75	ZINC	8	1000
09GYPB1040	F0786	40	ZINC	10	1000
09GYPB10100	F0785	100	ZINC	10	500

BUTTON HEAD NEEDLEPOINT SCREW



PART N°	QF	LENGTH (mm)	FINISH	SCREW GAUGE	QTY
09BUTS812	F0732	12	ZINC	8	1000
09BUTS816	F0733	16	ZINC	8	1000
09BUTS820	F0734	20	ZINC	8	1000
09BUTS825	F0735	25	ZINC	8	1000
09BUTS832	F0736	32	ZINC	8	1000

CHIPBOARD SCREW



PART N°	QF	LENGTH (mm)	FINISH	SCREW GAUGE	QTY
09CBS820	F0754	20	ZINC	8	1000
09CBS825	F0755	25	ZINC	8	1000
09CBS832	F0758	32	ZINC	8	1000
09CBS835	F0760	35	ZINC	8	1000
09CBS840	F0762	40	ZINC	8	1000
09CBS845	F0764	45	ZINC	8	1000
09CBS850	F0766	50	ZINC	8	1000
09CBS857	F0768	57	ZINC	8	500
09CBS1065	F0750	65	ZINC	10	500
09CBS1075	F0752	75	ZINC	10	500
09CBS10100	F0744	100	ZINC	10	500
09CBS10125	F0747	125	ZINC	10	500
09CBS10150	F0749	150	ZINC	10	500

PAN HEAD NEEDLEPOINT SCREW

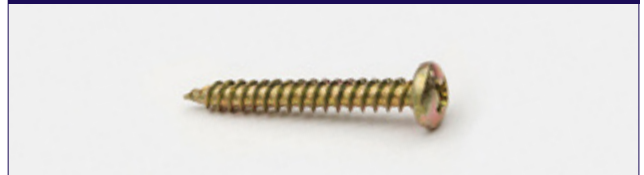

PART N°	QF	LENGTH (mm)	FINISH	SCREW GAUGE	QTY
09PE620	F0875	20	ZINC	6	1000
09PE630	F0876	30	ZINC	6	1000
09PE640	F0877	40	ZINC	6	1000
09PE650	F0878	50	ZINC	6	1000
09PE712	F0879	12	ZINC	7	1000
09PE720	F0880	20	ZINC	7	1000
09PE725	F0881	25	ZINC	7	1000
09PE730	F0882	30	ZINC	7	1000
09PE740	F0883	40	ZINC	7	1000
09PE750	F0884	50	ZINC	7	1000

SELF EMBEDDING HEAD NEEDLEPOINT SCREW

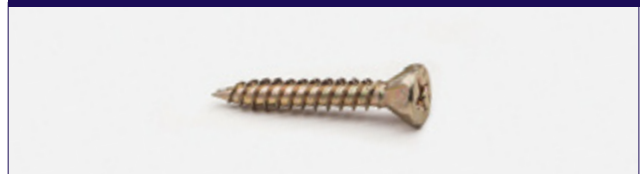

PART N°	QF	LENGTH (mm)	FINISH	SCREW GAUGE	QTY
09SEHS820	F0904	20	ZINC	8	1000
09SEHS830	F0905	30	ZINC	8	1000

RIVETS

RIVETS



ALUMINIUM RIVET - ALUMINIUM BODY WITH STEEL STEM

PART N°	QF	LENGTH (mm)	SIZE (mm)	HOLE SIZE (mm)	FASTENS (mm)	QTY
09AS41	F0671	5	3.2	(1/8)	1.6	1000
09AS42	F0674	6	3.2	(1/8)	3.2	1000
09AS43	F0676	8	3.2	(1/8)	4.8	1000
09AS44	F0679	10	3.2	(1/8)	6.4	1000
09AS46	F0683	15	3.2	(1/8)	9.6	1000
09AS48	F0684	18	3.2	(1/8)	12.7	1000
09AS410	F0672	20	3.2	(1/8)	16	1000
09AS54	F0689	10	4	(5/32)	6.4	1000
09AS56	F0693	15	4	(5/32)	9.6	1000
09AS610	F0696	20	4.8	(3/16)	16	500
09AS612	F0697	24	4.8	(3/16)	19	250
09AS620	F0699	6	4.8	(3/16)	3.2	1000
09AS622	F0701	35	4.8	(3/16)	32	150
09AS63	F0702	8	4.8	(3/16)	4.8	1000
09AS64	F0703	10	4.8	(3/16)	6.4	1000
09AS66	F0707	15	4.8	(3/16)	9.6	500
09AS68	F0709	18	4.8	(3/16)	12.7	500

STEEL RIVET - STEEL BODY WITH STEEL STEM

PART N°	QF	LENGTH (mm)	SIZE (mm)	HOLE SIZE (mm)	FASTENS (mm)	QTY
09SS42	F0909	6	3.2	(1/8)	3.2	1000
09SS43	F0910	8	3.2	(1/8)	4.8	1000
09SS44	F0911	10	3.2	(1/8)	6.4	1000
09SS45	F0912	12	3.2	(1/8)	8	1000
09SS46	F0913	15	3.2	(1/8)	9.6	1000
09SS48	F0914	18	3.2	(1/8)	12.7	1000
09SS52	F0915	6	4	(5/32)	3.2	1000
09SS53	F0916	8	4	(5/32)	4.8	1000
09SS54	F0917	10	4	(5/32)	6.4	1000
09SS55	F0920	12	4	(5/32)	8	1000
09SS62	F0922	6	4.8	(3/16)	3.2	500
09SS63	F0923	8	4.8	(3/16)	4.8	500
09SS64	F0924	10	4.8	(3/16)	6.4	500
09SS68	F0927	18	4.8	(3/16)	12.7	500

STAINLESS RIVET - STAINLESS BODY WITH STAINLESS STEM

PART N°	QF	LENGTH (mm)	SIZE (mm)	HOLE SIZE (mm)	FASTENS (mm)	QTY
09STST42	F1039	6	3.2	(1/8)	3.2	1000
09STST43	F1040	8	3.2	(1/8)	4.8	1000
09STST44	F1041	10	3.2	(1/8)	6.4	1000
09STST46	F1042	15	3.2	(1/8)	9.6	1000



◆ Consumables & Safety





CONTENTS	PAGE
SILICONE	128
SEALANTS	128
ADHESIVES	129
BACKER ROD	129
GROUT AND CONCRETE	129
TAPES	129
SOLVENTS AND CLEANERS	130
CUTTING LUBRICANTS	131
MARKERS	131
PERMANENT MARKERS	131
PAINT	132
CRAYONS	132
CHALK	133
BUILDING PRODUCTS	133
STRING LINES	133
WELDING	134
WELDING RODS	135
BATTERIES	135
HAND PROTECTION	136
HEAD PROTECTION	136
HEARING PROTECTION	137
EYE AND FACE PROTECTION	137
RESPIRATORY PROTECTION	138
SITE SAFETY	138
FIRE EXTINGUISHERS	139



SILICONE

HIGH PERFORMANCE SILICONE



PART N°	COLOUR	SIZE (g)
20GES300AG	ALU GREY	300

SANITARY SILICONE



PART N°	COLOUR	SIZE (g)
20SSHB300C	CLEAR	300
20SSHB300W	WHITE	300

GENERAL PURPOSE SILICONE



PART N°	COLOUR	SIZE (g)
20ST300	CLEAR	300
20SAL300-M	ALU GREY	300
20SAL300	ALU GREY	300
20SG300	WHITE	300

SEALANTS

See page 166 for caulking guns and sausage guns.

ACRYLIC GAP FILLER

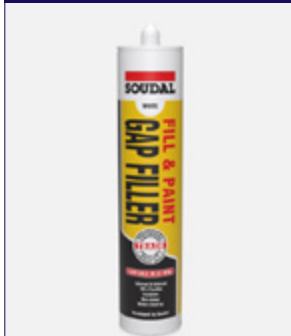

PART N°	COLOUR	SIZE (ml)
20AGF300	WHITE	300

DUCT SEALANT

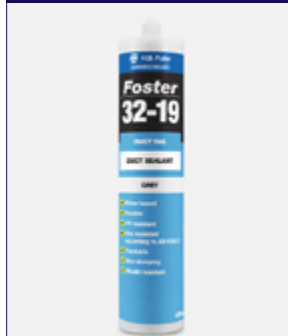

PART N°	COLOUR	SIZE (g)
20VS32-19	GREY	420

HEAT RESISTANT SEALANT



PART N°	COLOUR	SIZE (g)
20RTV260	RED	300

SIKAFLEX 11FC SEALANT



PART N°	COLOUR	SIZE (ml)
20SIKA11FC-B	BLACK	310
20SIKA11FC-G	GREY	310
20SIKA11FC-W	WHITE	310

FIRE RATED FIRESOUND



* Refer page 166 for Sausage Guns

PART N°	COLOUR	SIZE
22FS300	GREY	450g
22FS600	GREY	600ml

FIRE RATED FYREFLEX



* Refer page 166 for Sausage Guns

PART N°	COLOUR	SIZE
22FF300	GREY	450g
22FF600	GREY	600ml
22FF300W	WHITE	450g
22FF600W	WHITE	600ml

FIREMASTIC-HPE SEALANT



* Refer page 166 for Sausage Guns

PART N°	COLOUR	SIZE (ml)
22FMHPE300	GREY	310
22FMHPE600	GREY	600

EXPANDING FOAM



PART N°	COLOUR	SIZE (ml)
20SF500	White	500
20SF750	White	750
22FFFOAM	White	750
20TF750	White	750



ADHESIVES

CONSTRUCTION ADHESIVE



PART N°	COLOUR	SIZE
20CA300	Beige	350g
20Trex-W	White	310ml
20Trex-Clear	Clear	310ml

INSULATION ADHESIVE



PART N°	QF	SIZE	QTY
20KEM520	I0228	500ML	8

BACKER ROD

RECTANGULAR BACKER ROD



PART N°	QF	LENGTH (mm)	SIZE (mm)	QTY
20BACKER3020	I0193	2000	30 x 20	1

ROUND BACKER ROD



Other sizes and roll lengths available.

PART N°	QF	LENGTH (mm)	SIZE (mm)	QTY
20BACKER20	I0190	1	20	1
20BACKER25	I0191	1	25	1
20BACKER30	I0192	1	30	1

GROUT AND CONCRETE

NON SHRINK GROUT



PART N°	QF	QTY
20NSG20	I0235	64

PREMIX CONCRETE



PART N°	QF	QTY
20PMC20	I0241	1

TAPES

ALUMINIUM TAPE - PLAIN



PART N°	QF	SIZE (mm)	QTY
21AT50P	C1111	50	24
21AT72P	C1114	72	16

ALUMINIUM TAPE - REINFORCED

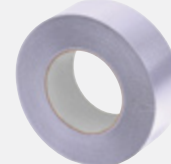

PART N°	QF	SIZE (mm)	QTY
21AT50R	C1113	50	24
21AT72R	C1116	72	16
21AT96R	-	96	12
21AT144R	-	144	8



DOUBLE SIDED TAPE



PART N°	QF	QTY
21DST1	I0296	10

MASKING TAPE



PART N°	QF	SIZE (mm)	QTY
21MTAPE50	I0306	25	10
21MTAPE50	I0309	50	10

DUCT TAPE



PART N°	QF	COLOUR	QTY
21DT13B	I0297	BLACK	64
21DT13G	I0298	GREY	64
21DT13W	I0299	WHITE	64

SOLVENTS AND CLEANERS

ACETONE



PART N°	QF	SIZE	QTY
30ACET	I1173	1L	6

BIG BLU SPRAY



PART N°	SIZE	QTY
30LDFB985	985ML	1

DEGREASER



PART N°	QF	QTY
30DEG	I1191	12

SILICONE SPRAY

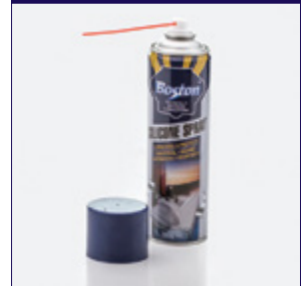

PART N°	QF	QTY
30SSPRAY	I1263	12

METHYLATED SPIRITS



PART N°	QF	SIZE	QTY
30METHO	I1219	1L	12

TURPENTINE



PART N°	QF	SIZE	QTY
30TURPS	I1275	1L	12

ALCOHOL WIPES



PART N°	QF	QTY
27ALCHWIPE	I0975	12

SCOTCHBRITE PADS



* Please Note: Packs of 4

QF	PART N°	QTY
I1254	30SBRITE	12

REDBACK CLEANING ABRASIVE



PART N°	QF	SIZE	QTY
30RBCA	I1247	1M	1
30RBCA-5	I1248	5M	1

RAGS



PART N°	QF	COLOUR	QTY
30RAGS	I1245	ASSORTED	1
30RAGS-W	I1246	WHITE	1

STEEL WOOL



* Please Note: Packs of 12

PART N°	QF	QTY
30SWOOL	I1266	1



CUTTING LUBRICANTS

INOX LUBRICANT SPRAY



PART N°	QF	QTY
30SSINOX	10743	12

MULTI-PURPOSE LUBRICANT



PART N°	QF	QTY
30RP7	11249	12

CUTTING LIQUID



PART N°	QF	QTY
25MCT500	10746	1

CUTTING COMPOUND



PART N°	QF	QTY
25MCC500	10745	1

CUTTING LUBRICANT PASTE



PART N°	QF	QTY
25RBCL	10786	1

EMERY PAPER
Please see page 163.

MARKERS

PAINT MARKERS



PART N°	QF	COLOUR	QTY
29DMWH	11169	WHITE	12
29DMYL	11170	YELLOW	12

PERMANENT MARKERS

MILWAUKEE PERMANENT MARKERS



PART N°	QF	COLOUR	QTY
29PM-BLK	11160	BLACK	36
29PM-BLU	11161	BLUE	36

HIGHLIGHTERS



PART N°	QF	QTY
29HIGHL	11149	1

STAEDTLER 352 LUMOCOLOR PERMANENT MARKER BULLET TIP



PART N°	QF	COLOUR	QTY
29PM-DCT	11329	BLACK	1

CARPENTER PENCIL



PART N°	QF	QTY
29CPENC	11137	10



PAINT

SPOT MARKING PAINT



PART N°	QF	COLOUR	QTY
29APSMB	I1122	BLUE	12
29APSMFG	I1123	GREEN	12
29APSMO	I1124	ORANGE	12
29APSM P	I1125	PINK	12
29APSMR	I1126	RED	12
29APSMW	I1127	WHITE	12
29APSMY	I1128	YELLOW	12

PAINT BRUSHES



PART N°	QF	SIZE (mm)	QTY
29PBRUSH25	I1157	25	12
29PBRUSH50	I1158	50	12
29PBRUSH75	I1159	75	12
29PBRUSH100	I1156	100	12

SPRAY PAINT



PART N°	QF	COLOUR	QTY
29APCG	I1113	COLD GAL	12
29APFB	I1114	FLAT BLACK	12
29APGB	I1115	GLOSS BLACK	12
29APGC	I1116	GLOSS CLEAR	12
29APGW	I1117	GLOSS WHITE	12
29APRO	I1119	RED OXIDE	12
29APSG	I1120	SILVER GAL	12
29APSI	I1121	SILVER	12

CRAYONS

LUMBER CRAYONS



PART N°	QF	DESCRIPTION	QTY
29CRAY-BL	I1143	BLACK	12
29CRAY-W	I1146	WHITE	12
29CRAY-R	I1145	RED	12
29CRAY-B	I1142	BLUE	12
29CRAY-Y	I1147	YELLOW	12



CHALK

ENGINEERING CHALK



* Please Note: Packs of 50

PART N°	QF	QTY
29ECHK	I1148	1

MARKING CHALK



PART N°	QF	COLOUR	QTY
29CR004B	I1138	BLUE	6
29CR004R	I1139	RED	6
29CR004Y	I1140	YELLOW	6
29CR006-BLK	I1141	BLACK	6

CHALK REEL



PART N°	QF	QTY
29LCR30	I1153	1

BUILDING PRODUCTS

HALF SHIMS



PART N°	QF	SIZE (mm)	MATERIAL SIZE (mm)	QTY
11HSHIM01	I0155	1	100 x 75	400
11HSHIM02	I0156	2	100 x 75	400
11HSHIM03	I0157	3	100 x 75	200
11HSHIM05	I0158	5	100 x 75	200
11HSHIM10	I0159	10	100 x 75	80
11HSHIM15	I0160	15	100 x 75	80
11HSHIM20	I0161	20	100 x 75	60

PAKAS



PART N°	QF	SIZE (mm)	MATERIAL SIZE (mm)	QTY
11PAKA016	I0163	1.5	75	200
11PAKA032	I0164	3.2	75	200
11PAKA050	I0165	5	75	200
11PAKA064	I0166	6.4	75	200
11PAKA100	I0162	10	75	100

BLACK POLY FILM



PART N°	QF	QTY
30POLY	I1239	1

MALTHOID



PART N°	QF	SIZE (mm)	QTY
30MALTHOID	I1218	110	1

PIZZA PLATE COVER



PART N°	QF	OUTSIDE DIA (mm)	QTY
20PT200	I0249	224	50

METAL STRAPPING HOOP IRON



PART N°	QF	DESCRIPTION	QTY
14MS25	I0175	SLOTTED STRAP	5
14MP25	-	SOLID STRAP	5
14TENS	I0176	TENSIONER	10

PLASTIC BUILDERS BAG



PART N°	SIZE
30A1PLANBAG100UM	610 x 915mm x 100units
30AOPLANBAG	1200 x 850mm x 50units
30AOPLANBAG10	1200 x 850mm x 10units
30DRUMLINER	Suits 44 gallon drum

STRING LINES

STRING LINE - FLURO



PART N°	QF	QTY
29LBL100FL	I1152	12

STRING LINE - WHITE



PART N°	QF	QTY
29LBL100	I1151	12



WELDING

BIG RED WELDING GLOVES



PART N°	QF	QTY
27WGLOVBR	I1088	1

WELDING GLOVES



PART N°	QF	QTY
27WGLOV	I1087	1

WELDING HELMET



PART N°	QF	DESCRIPTION	QTY
27LENSC	I1044	CLEAR LENS	1
27LENS	I1045	SHADED LENS	1
27WH	I1090	HELMET	1

WELDING SPECS SHADE 5



PART N°	QF	QTY
27WGOG	I0973	1

OXY WELDING TIPS



PART N°	QF	SIZE	QTY
30OXY8	I1230	8	1
30OXY10	I1226	10	1
30OXY12	I1227	12	1
30OXY15	I1228	15	1
30OXY20	I1229	20	1



SILVER SOLDER



PART N°	QF	DESCRIPTION	QTY
30SSOLD2-25	I1261	2%	1
30SSOLD5-25	I1262	5%	1
30SSOLD15-25	-	15%	1

SILVER SOLDER FLUX



PART N°	QF	QTY
30SSFLUX	I1259	1



WELDING RODS

WELDING RODS



* 5 KG Packs

FERROCRAFT 11

PART N°	QF	SIZE (mm)	QTY
30FERRO1132	I1194	3.2	1
30FERRO1140	I1195	4	1

WELDCRAFT

PART N°	QF	SIZE (mm)	QTY
30WELD25	I1281	2.5	1

SATINCRAFT 13

PART N°	QF	SIZE (mm)	QTY
30SATIN1325	I1251	2.5	1
30SATIN1332	I1252	3.2	1
30SATIN1340	I1253	4	1

BATTERIES

6V TORCH BATTERY



PART N°	QF	QTY
28BAT6V	I1100	6

STANDARD BATTERIES



PART N°	QF	DESCRIPTION	QTY
28BAT9V	I1097	9V	12
28AAABAT	I1098	AAA	12
28AABAT	I1099	AA	12
28CBAT	I1101	C	12
28DBAT	I1102	D	12



HAND PROTECTION

BLACK KNIGHT GLOVES



PART N°	QF	SIZE	QTY
27BKGLOV7	I0987	S	12
27BKGLOV8	I0988	M	12
27BKGLOV9	I0989	L	12
27BKGLOV10	I0985	XL	12
27BKGLOV11	I0986	XXL	12

GLOVE KEEPER CLIP



PART N°	QF	QTY
27GLOVECLIP	I1015	1

KEVLAR GLOVES



PART N°	QF	SIZE	QTY
27GCF178-07	I1040	S	12
27GCF178-08	I1041	M	12
27GCF178-09	I1042	L	12
27GCF178-10	I1038	XL	12
27GCF178-11	I1039	XXL	12

DISPOSABLE GLOVES



* Please Note: Box of 100

PART N°	QF	QTY
27DGLOV	I0996	1

HEAD PROTECTION

HARD HAT



PART N°	QF	DESCRIPTION	QTY
27HDHT	I1025	WHITE HARD HAT	1
27HCCS	I1023	CHIN STRAP	1
27HCSB	I1024	SWEAT BAND	1
27HDHTVC	I1026	SUN VISOR	1



HEARING PROTECTION

UNCORDED EAR PLUGS



PART N°	QF	QTY
27LL-1	I1046	1

CORDED EAR PLUGS



PART N°	QF	QTY
27LL-30	I1047	1

QB3 EAR PLUGS



PART N°	QF	DESCRIPTION	QTY
27QB3	I1056	QUIET BANDS	1
27QB3RP	I1057	REPLACEMENT PLUGS	50

EAR MUFFS



PART N°	QF	QTY
272000	I0965	1

PREMIUM EAR MUFFS



PART N°	QF	QTY
27H7A	I1022	1

HARD HAT EAR MUFFS



PART N°	QF	QTY
27HDH-MUFF	I1035	1

EYE AND FACE PROTECTION

CLEAR SAFETY GLASSES



PART N°	QF	QTY
279165 SPECS	I0972	12

AMBER SAFETY GLASSES



PART N°	QF	QTY
27SSPECS-AMBER	I1075	12

SAFETY SUNGLASSES



PART N°	QF	QTY
279165 SSS	I0967	12

FACE SHIELD



PART N°	QF	QTY
27FS	I1010	1

GOGGLE FACE SHIELD



PART N°	QF	QTY
27GVCOMBO	-	1

FOAM SEALED SAFETY GOGGLES



PART N°	QF	QTY
27TEC2	I0969	12

SAFETY GOGGLES

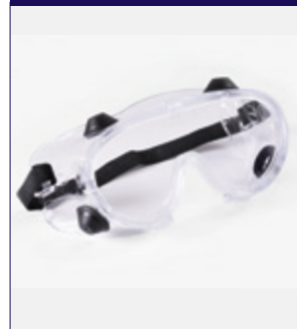

PART N°	QF	QTY
27DUSTGOG	I0966	12



RESPIRATORY PROTECTION

HALF FACE MASK



PART N°	QF	QTY
27RRS01-KIT	I1028	1

HALF FACE MASK CARTRIDGES



PART N°	QF	QTY
27RRF2128	I1027	10

SITE SAFETY

DISPOSABLE COVERALLS



PART N°	QF	QTY
27DOV	I0997	1

NUISANCE DUST MASK



* Please Note: Box of 50

PART N°	QF	QTY
27DUST	I0998	1

P1 TWIN STRAP DUST MASK



* Please Note: Box of 20

PART N°	QF	QTY
27FFP1	I1002	1

P2 TWIN STRAP DUST MASK WITH VALVE



* Please Note: Box of 10

PART N°	QF	QTY
27FFP2V	I1003	1

SAFETY VEST



PART N°	QF	QTY
27SV	I1079	1



SUNSCREEN



PART N°	QF	SIZE	QTY
27SS500	I1072	500ML	1

BAR GUARD CAP



PART N°	QF	QTY
27BG	I0981	100

HAZARD TAPE



PART N°	QF	QTY
27HT	I1036	20

HAND CLEANER



PART N°	QF	SIZE	QTY
27YUK500	I1091	500ml	1
27YUK5000	I1092	5L	1

FLAG BUNTING



PART N°	QF	LENGTH	QTY
27BNTG	I0994	30MTR	1
27BNTG-B	-	30MTR	1

STAR PICKET



* Refer page 167 for Driver Tools

PART N°	QF	LENGTH (mm)	QTY
27STAR1650	I1078	1650	10

SAFETY BOLLARD



PART N°	QF	QTY
27BOLLARD	I0992	1

TEST TAGS



PART N°	QTY
37TTSLYELLOW	100

BARRICADE MESH



PART N°	QF	SIZE	QTY
27BMSH	I0991	50MTR	1

FIRE EXTINGUISHERS

FIRE EXTINGUISHER - ABE



PART N°	QF	DESCRIPTION	QTY
22FO210	I0312	1KG	1
22FO230	I0313	2KG	1
22FO450	-	4.5KG	1
22FEXT9.0	-	9KG	1



◆ Tools



Tools

CONTENTS	PAGE
THREADED ROD CUTTERS	142
METAL STUD PUNCH	142
PIPE CUTTERS	142
ZIP-CLIP TOOLS	142
VELPRESS TOOLS	143
DROP-IN SETTING TOOLS	144
HOLLOW WALL ANCHOR SETTING TOOL	144
CHEMICAL ANCHOR TOOLS	144
COBRA GAS TOOLS	146
MILWAUKEE 18V SKINS	147
MILWAUKEE 18V TOOL KITS	150
MILWAUKEE 12V SKINS	150
MILWAUKEE BATTERIES AND CHARGERS	151
NOVOPRESS PRESS TOOLS	151
LASERS	151
EXACTCUT SAW KITS	151
EXTENSION LEAD HOOKS	151
PORTABLE POWER AND LIGHTS	151
SDS BITS	152
DIAMOND CORE DRILLS	154
DIAMOND CORE BITS	155
HSS DRILL BITS	156
SCREWDRIVER BITS	157
SPEAR BITS	157
RIGHT ANGLE DRIVE	157
AUGER BITS	158
SPADE BITS	158
HOLESAWS	160
CUT OFF WHEELS	162
INTERNAL PIPE CUTTER	162
GRINDING WHEELS	162
DIAMOND BLADES	162
SAW BLADES	163
FLAP DISCS	163
WIRE WHEELS	163
SANDPAPER	163
RECIPRO BLADES	164
JIGSAW BLADES	164
HACKSAW BLADE	165
MULTI TOOL BLADE	165
KNIVES AND BLADES	165
CAULKING GUNS	166
SOLDERING TOOLS	166
DUCT TOOLS	167
BROOMS	167
SPANNERS AND SOCKETS	167
STAR PICKET TOOL	167
GENERAL TOOLS	168
CABLE TIE TENSIONERS	168
PLATFORM LADDERS	169
STORAGE EQUIPMENT & SOLUTIONS	169



THREADED ROD CUTTERS

THREADED ROD CUTTER



PART N°	QF	QTY
13NKM10	J0191	1
13NKM12	J0192	1

METAL STUD PUNCH

METAL STUD PUNCH



PART N°	QF	QTY
26STP710	J0458	1

PIPE CUTTERS

PIPE SCISSORS



PART N°	QF	SIZE (mm)	QTY
40CXLZ-SC1	J0959	16-32	1

PIPE CUTTING TOOL



PART N°	QF	SIZE (mm)	QTY
40CXLZ-QGQ	J0958	25-63	1

ROD CUTTER REPLACEMENT BLADES



PART N°	QF	TO SUIT	THREAD SIZE	QTY
13RCBM06	J0187	PURPLE CUTTER	M6	1
13RCBM08	J0188	PURPLE CUTTER	M8	1
13RCBM10	J0189	PURPLE CUTTER	M10	1
13RCBM12	J0190	PURPLE CUTTER	M12	1
13NKMRB	J0182	RED CUTTER	M10	1
13NKRB12	J0183	GREEN CUTTER	M12	1

ZIP-CLIP TOOLS



Acura also sell a complete range of tools for the Zip-Clip system. Ask us what is most suitable for your next project.

ZIP-CLIP TENSIONER



PART N°	QF	QTY
17TT1	J0198	1

ZIP-CLIP CUTTER



PART N°	QF	QTY
17ZIPCUT	J0197	1



VELPRESS TOOLS

VELPRESS MINI JAWS



* Suits Novopress ACO153

PART N°	QF	TO SUIT	QTY
39PT-VPMJ15	J0913	15CU	1
39PT-VPMJ20	J0915	20CU	1
39PT-VPMJ25	J0917	25CU	1
39PT-VPMJ32	J0919	32CU	1

VELPRESS JAWS



* Suits Novopress ACO203

PART N°	QF	TO SUIT	QTY
39PT-VPJ015	J0900	15CU	1
39PT-VPJ020	J0901	20CU	1
39PT-VPJ025	J0902	25CU	1
39PT-VPJ032	J0903	32CU	1
39PT-VPJ040	J0904	40CU	1
39PT-VPJ050	J0905	50CU	1

VELPRESS XL JAW ADAPTER



* Suits Novopress ACO203

PART N°	QF	QTY
39PT-VPJA65100	J0908	1

VELPRESS XL RING JAWS



* Suits Novopress ACO203 with Jaw Adapter

PART N°	QF	TO SUIT	QTY
39PT-VPJ065	J0906	65CU	1
39PT-VPJ080	J0907	80CU	1
39PT-VPJ100	J0899	100CU	1

VELPRESS MINI TOOL KIT 15-32



PART N°	QF	QTY
39PT-VPM12FL1532K	J0911	1

VELPRESS TOOL AND JAW KIT 15-50



PART N°	QF	QTY
39PT-VP18FL1550K	J0898	1

VELPRESS JAW KIT 40-50MM



PART N°	QF	QTY
39VPJK4050	J0948	1

VELPRESS XL JAW KIT 65-100



* Suits Novopress ACO203

PART N°	QF	QTY
39PT-VPJK65100	J0910	1



DROP-IN SETTING TOOLS

DROP-IN SETTING TOOL



PART N°	QF	TO SUIT	QTY
02SET6	J0146	M6	1
02SET8	J0147	M8	1
02SET10	J0139	M10	1
02SET12	J0142	M12	1
02SET16	J0144	M16	1
02SET20	J0145	M20	1

DROP-IN SETTING TOOL - HEAVY DUTY



PART N°	QF	TO SUIT	QTY
02SET10HD	J0140	M10	1
02SET12HD	J0143	M12	1

ROTARY HAMMER DROP IN SETTING TOOL



PART N°	QF	TO SUIT	QTY
02D10M30PUNCH	J0141	M10 Drop-In	1

HOLLOW SET DROP-IN SETTING TOOL



PART N°	QF	QTY
02HSDTM10TOOL	J0138	1

HOLLOW WALL ANCHOR SETTING TOOL

HOLLOW WALL ANCHOR SETTING TOOL



PART N°	QF	QTY
07HWAST-200	J0161	1

CHEMICAL ANCHOR TOOLS

4 IN 1 MULTIPRO GUN



PART N°	QF	QTY
03CGPRO	J0152	1

KEMFAST CHEMICAL GUN



PART N°	QF	QTY
03CG380KF2LD	J0151	1

HOLE CLEANING BRUSH



PART N°	QF	QTY
03BR10-14MM	J0149	1
03BR16-28MM	J0150	1

BLOW PUMP



PART N°	QF	QTY
03BLOWPUMP	J0148	1



Cobra V **GS 738C**

Cordless SuperPinner

Product Features

- Weighs only 3.46kg
- Easy to adjust depth control
- Easy to position in the corner with contact nose
- Easy jam clearance
- Ultra-light swing trigger - only 1.2kg
- Stainless steel mesh filters
- Easy one-step pin loading
- Easy to load fuel cell
- Soft moulded grip
- LED low battery indicator
- Reversible belt loop hook

POWER
QUALITY
RELIABILITY



105 joules max power

Short track rail enabling easy movement

Smart Fan

Ultra Light Trigger

Direct Fuel Injection



COBRA GAS TOOLS

COBRA DXG3000 GAS TOOL POLE



PART N°	QF	TO SUIT	QTY
0855053	J0162	DXG3000	1
0856347	J0166	COBRA V	1

COBRA V GAS TOOL



PART N°	QF	QTY
08GS738C	J0174	1

COBRA DXG3000 GAS TOOL



PART N°	QF	QTY
08DXG3000	J0170	1

COBRA DXG3000 ADAPTER CORD



PART N°	QF	TO SUIT	QTY
08DXG3000-AC	J0171	DXG3000	1

COBRA DXG3000 BATTERY



PART N°	QF	TO SUIT	QTY
08DXG3000-B	J0172	DXG3000	1

COBRA DXG3000 CHARGER BASE



PART N°	QF	TO SUIT	QTY
08DXG3000-CB	J0173	DXG3000	1

MILWAUKEE 18V SKINS

MILWAUKEE 18V 22MM ROTARY HAMMER - SKIN ONLY



PART N°	QF	QTY
39HD18H-0	J0718	1

MILWAUKEE FUEL 18V 28MM ROTARY HAMMER - SKIN ONLY



PART N°	QF	QTY
39M18CHP-0	J0792	1

MILWAUKEE FUEL 18V CIRCULAR SAW - SKIN ONLY



PART N°	QF	QTY
39M18CCS55-0	J0790	1

MILWAUKEE FUEL 18V METAL SAW - SKIN ONLY



PART N°	QF	QTY
39M18FMCS-0	J0812	1

MILWAUKEE 18V ANGLE GRINDER - SKIN ONLY



PART N°	QF	QTY
39HD18AG125-0	J0712	1

MILWAUKEE FUEL 18V RECIPRO SAW - SKIN ONLY



PART N°	QF	QTY
39M18CSX-0	J0806	1



MILWAUKEE 18V HACKSAW - SKIN ONLY



PART N°	QF	QTY
39C18HZ-0	J0688	1

MILWAUKEE 18V BLOWER - SKIN ONLY



PART N°	QF	QTY
39M18BBL-0	J0772	1

MILWAUKEE 18V LED TORCH - SKIN ONLY



PART N°	QF	QTY
39M18TLED	J0824	1

MILWAUKEE 18V THREADED ROD CUTTER - SKIN ONLY



PART N°	QF	QTY
39M18BLTRC-0X	J1038	1

MILWAUKEE 18V HP AREA LIGHT 3000LU - SKIN ONLY



PART N°	QF	QTY
39M18HAL-0	J0818	1

MILWAUKEE 18V LED AREA LIGHT - SKIN ONLY



PART N°	QF	QTY
39M18AL-0	J0766	1

CUTTINGSTATION SS7

A go-anywhere, multi-purpose cutting station with unrivalled safety features to minimise vibration, sparks, noise and dust.

- Recessed 110v inlet power supply, and 2 x 110v internal sockets
- Extendable back panel provides extra workspace for mitre saws
- Sound deadening, fire-rated foam to reduce noise pollution
- PVC curtains to contain sparks
- Rubber mat to reduce vibration
- Rubberised wheels for reduced vibration
- Extendable support arms with 4 configurations
- Heavy-duty all-swivel wheels for easy moving
- Secure cabinet to keep your tools safe
- Swarf collector with dust extractor connection



SITESTATION SS2

Finally - a purpose-built solution to your on site work station needs

The SiteStation gives you a convenient place for performing routine on site tasks, while also providing secure storage for your valuable equipment. The top section features a folding slanted work surface – ideal for displaying plans and charts – which when shut provides an additional lockable storage area – ideal for power tools, PPE and fixings.

- Gas struts on both sides of top compartment
- Slanted, folding work surface with lockable concealed storage area
- Robust construction giving maximum protection
- Keyed-alike 2-point tamper-proof locking system
- Pockets on doors for smaller components
- Powder coated for maximum durability
- Full-width shelves in both lower and upper compartments
- Fork skids with fixing slots for easily adding castors



MILWAUKEE 18V TOOL KITS

MILWAUKEE FUEL 28MM ROTARY HAMMER M18 5.0AH



PART N°	QF	QTY
39M18CHP-0	J0794	1

MILWAUKEE FUEL ANGLE GRINDER M18 5.0AH



PART N°	QF	QTY
39M18CAG125XPD-0	J0787	1

MILWAUKEE FUEL IMPACT WRENCH M18 5.0AH



PART N°	QF	QTY
39M18FIWP12-0	J0811	1

MILWAUKEE HAMMER DRILL DRIVER M18 4.0AH



PART N°	QF	QTY
39M18FPD2-0	J0814	1

MILWAUKEE FUEL IMPACT DRIVER M18 5.0AH



PART N°	QF	QTY
39M18FID2-0	J0810	1

MILWAUKEE 12V SKINS

MILWAUKEE M12 10MM CROWN STAPLER - SKIN ONLY



PART N°	QF	QTY
39M12BST-0	J0752	1

MILWAUKEE 12V COPPER TUBE CUTTER - SKIN ONLY



PART N°	QF	QTY
39C12PC-0	J0682	1



MILWAUKEE BATTERIES AND CHARGERS

MILWAUKEE BATTERY CHARGER 12V - 18V



PART N°	QF	QTY
39M1218FC	J0687	1

MILWAUKEE BATTERY M12 3.0AH



PART N°	QF	QTY
39M12BX	J0748	1

MILWAUKEE BATTERY M18



PART N°	QF	DESCRIPTION	QTY
39M18B4	J0768	4.0Ah	1
39M18B5	J0769	5.0Ah	1
39M18B6	J0770	6.0Ah	1

NOVOPRESS PRESS TOOLS

NOVOPRESS TOOL KIT



PART N°	QF	QTY
39PT-18FL	J0867	1

NOVOPRESS 18V PRESS TOOL - SKIN ONLY



PART N°	QF	QTY
39PT-18FL-0	J1044	1

NOVOPRESS MINI TOOL KIT



PART N°	QF	QTY
39PT-12FLM	J0865	1

LASERS

7-WAY MULTI LASER



PART N°	QF	QTY
39MULTILINER	J0851	1

EXACTCUT SAW KITS

EXACTCUT SAW KITS



PART N°	QF	QTY
39EXACTCUT170	J1033	1
39EXACTCUT220	J1034	1

EXTENSION LEAD HOOKS

EXTENSION LEAD HOOK



PART N°	QF	QTY
28EXLMK	I1103	100

PORTABLE POWER AND LIGHTS

IBEAMIE LIGHTS



PART N°	DESCRIPTION	QTY
28WLED20W-R	WORK LIGHT	1
18LB02	HEAD LIGHT	1

EXTENSION LEADS



PART N°	QF	RATING	LENGTH	QTY
28EL20	J0464	10A	20MTR	5
28EL30	J0465	10A	30MTR	5
28EL15A30	J0466	15A	30MTR	1

SAFETY POWER OUTLET



PART N°	QF	QTY
28485P	J0461	1



SDS BITS

DRILLCUTTA SDS DRILL BIT



PART N°	QF	LENGTH (mm)	SIZE (mm)	QTY
24SDC06170	I0584	170	6	1
055866	-	160	6.5	1

SDS CHISELS



PART N°	QF	LENGTH (mm)	SIZE (mm)	QTY
24TIPC	I0623	250	POINT	1
24TIFC	I0622	250	25	1
24TIWC	I0624	250	40	1

SDS MAX CHISELS



PART N°	QF	LENGTH (mm)	SIZE (mm)	QTY
24MXC	I0508	400	25	1
24MXC600	I0509	600	25	1
24MXP	I0510	400	POINT	1
24MXP600	I0511	600	POINT	1
24MXW	I0512	400	50	1

SDS DUST CAP



PART N°	QF	QTY
25DUST	I0647	1

SDS CHUCK ADAPTER



PART N°	QF	QTY
25DCA	I0644	1

SDS PLUS DRILL BIT



PART N°	QF	LENGTH (mm)	SIZE (mm)	WORKING LENGTH (mm)	QTY
24S04160	I0517	160	4	100	1
24S05110	I0518	110	5	50	1
24S05160	I0520	160	5	100	1
24S05210	I0522	210	5	150	1
24S055110	I0523	110	5.5	50	1
24S055160	I0524	160	5.5	100	1
24S055210	I0525	210	5.5	150	1
24S06110	I0526	110	6	50	1
24S06160	I0527	160	6	100	1
24S06210	I0529	210	6	150	1
24S065110	I0530	110	6.5	50	1
24S065160	I0531	160	6.5	100	1
24S065210	I0533	210	6.5	150	1
24S07110	I0534	110	7	50	1
24S07160	I0535	160	7	100	1
24S08160	I0536	160	8	100	1
24S08210	I0538	210	8	150	1
24S08260	I0539	250	8	200	1
24S08450	I0540	450	8	400	1
24S10160	I0541	160	10	100	1
24S10210	I0543	210	10	150	1
24S10260	I0544	250	10	200	1
24S10450	I0545	450	10	400	1
24S12160	I0546	160	12	100	1
24S12210	I0548	210	12	150	1
24S12250	I0549	250	12	200	1
24S12450	I0550	450	12	400	1
24S13160	I0551	160	13	100	1
24S13250	I0552	250	13	200	1
24S14260	I0553	250	14	200	1
24S15160	I0554	160	15	100	1
24S15250	I0555	250	15	200	1
24S16160	I0556	160	16	100	1
24S16200	I0557	200	16	150	1
24S16300	I0558	300	16	250	1
24S16450	I0559	450	16	400	1
24S18200	I0560	200	18	150	1
24S18450	I0561	450	18	400	1
24S20200	I0562	200	20	150	1
24S20300	I0563	300	20	250	1
24S20450	I0564	450	20	400	1
24S22250	I0565	250	22	200	1
24S22450	I0566	450	22	400	1
24S24250	I0567	250	24	200	1
24S24450	I0568	450	24	400	1
24S25250	I0569	250	25	200	1
24S25450	I0570	450	25	400	1
24S26250	I0571	250	26	200	1
24S26450	I0572	450	26	400	1



SDS MULTI PACK



PART N°	QF	LENGTH (mm)	SIZE (mm)	WORKING LENGTH (mm)	QTY
24MP160	I0486	160	5, 6.5, 8, 10, 12	100	1

4 CUTTER SDS PLUS DRILL BIT



PART N°	QF	LENGTH (mm)	SIZE (mm)	WORKING LENGTH (mm)	QTY
24DTGNS05110	I0593	110	5	50	1
24DTGNS05166	I0594	160	5	100	1
24DTGNS05210	I0595	210	5	150	1
24DTGNS055160	I0596	160	5.5	100	1
24DTGNS06160	I0597	160	6	100	1
24DTGNS06210	I0598	210	6	150	1
24DTGNS64166	I0599	160	6.5	100	1
24DTGNS065210	I0600	210	6.5	150	1
24DTGNS08166	I0601	160	8	100	1
24DTGNS08216	I0602	210	8	150	1
24DTGNS10166	I0603	160	10	100	1
24DTGNS10216	I0604	210	10	150	1
24DTGNS12166	I0605	160	12	100	1
24DTGNS12216	I0606	210	12	150	1
24DTGNS016166	I0609	160	16	100	1
24DTGNS16260	I0610	250	16	200	1
24DTGNS18216	I0612	250	18	200	1
24DTGNS20300	I0614	250	20	200	1
24DTGNS20450	I0615	450	20	400	1
24DTGNS22450	I0616	450	22	400	1
24DTGNS24450	I0617	450	24	400	1
24DTGNS25450	I0618	450	25	400	1
24DTGNS28450	I0619	450	28	400	1
24DTGNS32450	I0620	450	30	400	1
24DTGNS32450	I0621	450	32	-	1

SDS MAX DRILL BIT



PART N°	QF	LENGTH (mm)	SIZE (mm)	WORKING LENGTH (mm)	QTY
24MAX12390	I0448	390	12	200	1
24MAX12540	I0449	540	12	400	1
24MAX13390	I0450	390	13	200	1
24MAX13540	I0451	540	13	400	1
24MAX14390	I0452	390	14	200	1
24MAX14540	I0453	540	14	400	1
24MAX15390	I0454	390	15	200	1
24MAX15540	I0455	540	15	400	1
24MAX16390	I0456	390	16	200	1
24MAX16540	I0457	540	16	400	1
24MAX18390	I0458	390	18	200	1
24MAX18540	I0459	540	18	400	1
24MAX20370	I0460	390	20	200	1
24MAX20520	I0461	520	20	400	1
24MAX22370	I0463	370	22	200	1
24MAX22520	I0464	520	22	400	1
24MAX24370	I0466	370	24	200	1
24MAX24520	I0467	520	24	400	1
24MAX25370	I0468	370	25	200	1
24MAX25520	I0469	520	25	400	1
24MAX26370	I0471	370	26	200	1
24MAX26520	I0472	520	26	400	1
24MAX28370	I0473	370	28	250	1
24MAX28570	I0474	570	28	400	1
24MAX30370	I0475	370	30	250	1
24MAX30570	I0476	570	30	400	1
24MAX32370	I0477	370	32	250	1
24MAX32570	I0478	570	32	400	1
24MAX35370	I0480	370	35	250	1
24MAX35570	I0481	570	35	400	1
24MAX38370	I0482	370	38	250	1
24MAX38570	I0483	570	38	400	1
24MAX40370	I0484	370	40	250	1
24MAX40570	I0485	570	40	400	1

DROP-IN SDS DRILL BIT

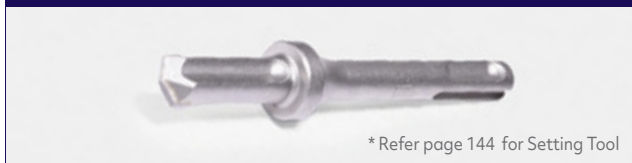

PART N°	QF	SIZE (mm)	TO SUIT	WORKING LENGTH (mm)	QTY
24SDROPIN	I0585	12	M10 Drop-In	45	1



DIAMOND CORE DRILLS

WET CORE DRILL



PART N°	QF	LENGTH (mm)	SIZE (mm)	THREAD SIZE	QTY
23CCD012	I0350	300	12	1-1/4UNC	1
23CCD014	I0351	450	14	1-1/4UNC	1
23CCD016	I0352	450	16	1-1/4UNC	1
23CCD020	I0353	450	20	1-1/4UNC	1
23CCD022	I0354	450	22	1-1/4UNC	1
23CCD024	I0355	450	24	1-1/4UNC	1
23CCD025	I0356	450	25	1-1/4UNC	1
23CCD028	I0357	450	28	1-1/4UNC	1
23CCD030	I0358	450	30	1-1/4UNC	1
23CCD032	I0359	450	32	1-1/4UNC	1
23CCD035	I0360	450	35	1-1/4UNC	1
23CCD038	I0361	450	38	1-1/4UNC	1
23CCD040	I0362	450	40	1-1/4UNC	1
23CCD045	I0363	450	45	1-1/4UNC	1
23CCD052	I0364	450	52	1-1/4UNC	1
23CCD062	I0365	450	62	1-1/4UNC	1
23CCD065	I0366	450	65	1-1/4UNC	1
23CCD072	I0369	450	72	1-1/4UNC	1
23CCD077	I0370	450	77	1-1/4UNC	1
23CCD082	I0371	450	82	1-1/4UNC	1
23CCD092	I0374	450	92	1-1/4UNC	1
23CCD102	I0375	450	102	1-1/4UNC	1
23CCD115	I0378	450	115	1-1/4UNC	1
23CCD127	I0379	450	127	1-1/4UNC	1
23CCD142	I0382	450	142	1-1/4UNC	1
23CCD152	I0383	450	152	1-1/4UNC	1
23CCD162	I0384	450	162	1-1/4UNC	1
23CCD165	I0385	450	165	1-1/4UNC	1
23CCD178	I0386	450	178	1-1/4UNC	1
23CCD205	I0387	450	205	1-1/4UNC	1
23CCD250	I0388	450	250	1-1/4UNC	1
23CCD305	I0389	450	305	1-1/4UNC	1
23CCD352	I0390	450	352	1-1/4UNC	1
23CCD405	I0391	450	405	1-1/4UNC	1
23CCD505	I0392	450	505	1-1/4UNC	1
23CCD605	I0393	450	605	1-1/4UNC	1

Wet Core Drills, premium quality diamond core drills designed for wet core drilling applications.

Ideal for cured, reinforced concrete. 1-1/4 UNC female thread connection.



DRY CORE DRILL



PART N°	QF	LENGTH (mm)	SIZE (mm)	THREAD SIZE	QTY
23DB028	I0406	160	28	1/2 BSP	1
23DB032	I0407	160	32	1/2 BSP	1
23DB042	I0408	160	42	1/2 BSP	1
23DB052	I0409	160	51	1/2 BSP	1
23DB067	I0410	160	67	1/2 BSP	1
23DB082	I0411	160	82	1/2 BSP	1
23DB102	I0412	160	102	1/2 BSP	1
23DB107	I0413	160	107	1/2 BSP	1
23DB117	I0414	160	117	1/2 BSP	1
23DB127	I0415	160	127	1/2 BSP	1

DRY CORE DRILL GUIDE ROD



PART N°	QF	QTY
23DAD03	I0400	1

DRY CORE DRILL PILOT DRILL

PART N°	QF	QTY
23DBATD	I0403	1

DRY CORE DRILL SDS TO BSP ADAPTER

PART N°	QF	QTY
23DBSDA	I0401	1

DRY CORE DRILL SDS ADAPTER PACK

PART N°	QF	QTY
23DBSADKIT	I0399	1

DRY CORE DRILL SDS MAX TO BSP ADAPTER

PART N°	QF	QTY
23DAD14	I0404	1

DRY CORE DRILL SDS MAX ADAPTER PACK

PART N°	QF	QTY
23DAD15	I0405	1

DRY CORE DRILL M - F EXTENSION

PART N°	QF	QTY
23DAD09	I0402	1

DIAMOND CORE BITS
DIAMOND WET CORE BIT - BSP

PART N°	QF	SIZE (mm)	QTY
23CCD06BSP	I0367	6	1
23CCD08BSP	I0372	8	1
23CCD10BSP	I0376	10	1
23CCD12BSP	I0380	12	1

DIAMOND WET CORE BIT - STRAIGHT

PART N°	QF	SIZE (mm)	QTY
23CCD06P10	I0368	6	1
23CCD08P10	I0373	8	1
23CCD10P10	I0377	10	1
23CCD12P10	I0381	12	1

DIAMOND GRIT CORE BIT

PART N°	QF	SIZE (mm)	QTY
23BOA6	I0340	6	1
23BOA8	I0341	8	1
23BOA10	I0335	10	1
23BOA12	I0336	12	1
23BOA16	I0337	16	1
23BOA20	I0338	20	1
23BOA25	I0339	25	1



HSS DRILL BITS

HSS DRILL BIT - METRIC



PART N°	QF	SIZE (mm)	TO SUIT	QTY
25HSS010	I0677	1		10
25HSS015	I0678	1.5		10
25HSS020	I0679	2		10
25HSS025	I0680	2.5		10
25HSS030	I0681	3		10
25HSS035	I0682	3.5		10
25HSS040	I0683	4		10
25HSS045	I0684	4.5		10
25HSS050	I0685	5		10
25HSS055	I0686	5.5		10
25HSS060	I0687	6		10
25HSS065	I0688	6.5		10
25HSS070	I0689	7		10
25HSS075	I0690	7.5		10
25HSS080	I0691	8		5
25HSS085	I0692	8.5		5
25HSS090	I0693	9		5
25HSS095	I0694	9.5		5
25HSS100	I0695	10		1

HSS REDUCED SHANK DRILL BIT - METRIC



PART N°	QF	SIZE (mm)	TO SUIT	QTY
25HSSRS105	I0725	10.5	3/8	1
25HSSRS110	I0726	11	3/8	1
25HSSRS115	I0727	11.5	3/8	1
25HSSRS120	I0728	12	3/8	1
25HSSRS125	I0729	12.5	3/8	1
25HSSRS130	I0730	13	3/8	1
25HSSRS140	I0732	14	1/2	1
25HSSRS160	I0734	16	1/2	1
25HSSRS180	I0735	18	1/2	1
25HSSRS200	I0736	20	1/2	1
25HSSRS220	I0737	22	1/2	1

HSS DRILL BIT - IMPERIAL



PART N°	QF	SIZE (mm)	TO SUIT	QTY
25HSS116	I0697	1/16in		10
25HSS564	I0719	5/64in		10
25HSS332	I0715	3/32in		10
25HSS764	I0721	7/64in		10
25HSS18	I0705	1/8in		10
25HSS964	I0723	9/64in		10
25HSS532	I0718	5/32in		10
25HSS1164	I0698	11/64in		10
25HSS316	I0714	3/16in		10
25HSS1364	I0701	13/64in		10
25HSS732	I0720	7/32in		10
25HSS1564	I0703	15/64in		10
25HSS14	I0702	1/4in		10
25HSS1764	I0704	17/64in		10
25HSS932	I0722	9/32in		10
25HSS1964	I0706	19/64in		10
25HSS516	I0717	5/16in		10
25HSS2164	I0709	21/64in		5
25HSS1132	I0696	11/32in		5
25HSS2364	I0710	23/64in		5
25HSS38	I0716	3/8in		1
25HSS2564	I0711	25/64in		1

HSS DRILL BIT SET



PART N°	QF	SIZE (mm)	QTY
25DSM19	I0645	1-10	1
25DSM25R	I0646	1-13	1

HSS DRILL BIT - DOUBLE END



PART N°	QF	SIZE (mm)	TO SUIT	QTY
25HSS11DE	I0699	3/16in	No.11	10
25HSS20DE	I0707	5/32in	No.20	10
25HSS30DE	I0712	1/8in	No.30	10

HSS DRILL BIT - SINGLE END



PART N°	QF	SIZE (mm)	TO SUIT	QTY
25HSS316	I0700	3/16in	No.11	10
25HSS532	I0708	5/32in	No.20	10
25HSS18	I0713	1/8in	No.30	10

HSS REDUCED SHANK DRILL BIT - IMPERIAL



PART N°	QF	SIZE (mm)	TO SUIT	QTY
25HSSRS1332	I0731	13/32in	3/8	1
25HSSRS2764	I0738	27/64in	3/8	1
25HSSRS716	I0741	7/16in	3/8	1
25HSSRS2964	I0739	29/64in	3/8	1
25HSSRS1532	I0733	15/32in	3/8	1
25HSSRS3164	I0740	31/64in	3/8	1
25HSSRSJ12	I0742	1/2in	3/8	1

STEP DRILL



PART N°	QF	SIZE (mm)	QTY
2513371	I0625	6-30	1
2513372	I0626	1/4-3/4in	1



SCREWDRIVER BITS

SCREWDRIVER BITS



PART N°	QF	LENGTH (mm)	TO SUIT	QTY
25PH25	I0764	25	PH2	10
25PH50	I0766	50	PH2	10
25PH75	I0768	75	PH2	10
25PH100	I0762	100	PH2	10
25PH150	I0763	150	PH2	10
25PH45	I0765	45	PH2	10
25PH65	I0767	65	PH2	10
25PH2+SL6	I0761	45	PH2/SL2	10
25HEX	I0656	25	HEX5	10
25SQ225S	I0814	25	SQ2	10
25TX10	I0827	25	TX10	10
25TX20	I0828	25	TX20	10
25TX25	I0829	25	TX25	10
25TX30	I0830	25	TX30	10
25TX40	I0831	25	TX40	10
25TX50	I0832	25	TX50	10

SPEAR BITS

SPEAR BIT



PART N°	QF	SIZE (mm)	QTY
24SPEAR5	I0590	5	1
24SPEAR6	I0591	6	1
24SPEAR8	I0592	8	1
24SPEAR10	I0588	10	1
24SPEAR12	I0589	12	1

MAGNETIC BIT HOLDER



PART N°	QF	QTY
25MHOLD	I0748	10

NUT SETTER



PART N°	QF	LENGTH (mm)	TO SUIT	QTY
25NS1065	I0749	65	10mm	1
25NS1355	I0750	55	13mm	1
25NS14	I0751	42	1/4in	10
25NS14L	I0752	42	1/4in	10
25NS516	I0756	42	5/16in	10
25NS516L	I0758	65	5/16in	10
25NS516L150	I0759	150	5/16in	10
25NS516XXL	-	200	5/16in	10
25NS38	I0753	42	3/8in	10
25NS38L	I0754	65	3/8in	10

SQUARE DRIVE ADAPTER



PART N°	QF	LENGTH (mm)	TO SUIT	QTY
25SDA1414	I0788	65	1/4in	1
25SDA1438	I0789	75	3/8in	1
25SDA1412	I0787	70	1/2in	1

RIGHT ANGLE DRIVE

RIGHT ANGLE DRIVE



PART N°	QF	QTY
39HD90D	J0373	1



AUGER BITS

AUGER BIT



PART N°	QF	LENGTH (mm)	SIZE (mm)	QTY
25AG20200	I0635	200	20	1
25AG20450	I0636	450	20	1
25AG22450	I0637	450	22	1
25AG25200	I0638	200	25	1
25AG25450	I0639	450	25	1

SPADE BITS

SPADE BIT



PART N°	QF	SIZE (mm)	QTY
25SP08	I0790	8	1
25SP10	I0791	10	1
25SP12	I0792	12	1
25SP14	I0793	14	1
25SP16	I0794	16	1
25SP18	I0796	18	1
25SP20	I0797	20	1
25SP22	I0799	22	1
25SP24	I0801	24	1
25SP25	I0802	25	1
25SP28	I0804	28	1
25SP32	I0806	32	1
25SP38	I0809	38	1

SPADE BIT EXTENSION



PART N°	QF	LENGTH (mm)	TO SUIT	QTY
25QREXT	I0811	300	1/4in	1

MADE IN U.S.A.



MORSE[®]

HOLE SAWS

Advanced Bi-Metal Hole Saws

The latest sawing innovation.

Applications

Wood, plastic, machinable metals, stainless steel, nail-embedded wood.

Features & Benefits

- Patent pending tooth set design
- New cap - reduces runout and vibration
- Premium M42 high speed steel cutting edge, 8% cobalt - over 2 X greater life span
- Cutting depth - 1-15/16" (49.2 mm)
- Heavy duty .050 Side Wall - For greater stability
- New side slot - increased leverage for faster, easier slug removal

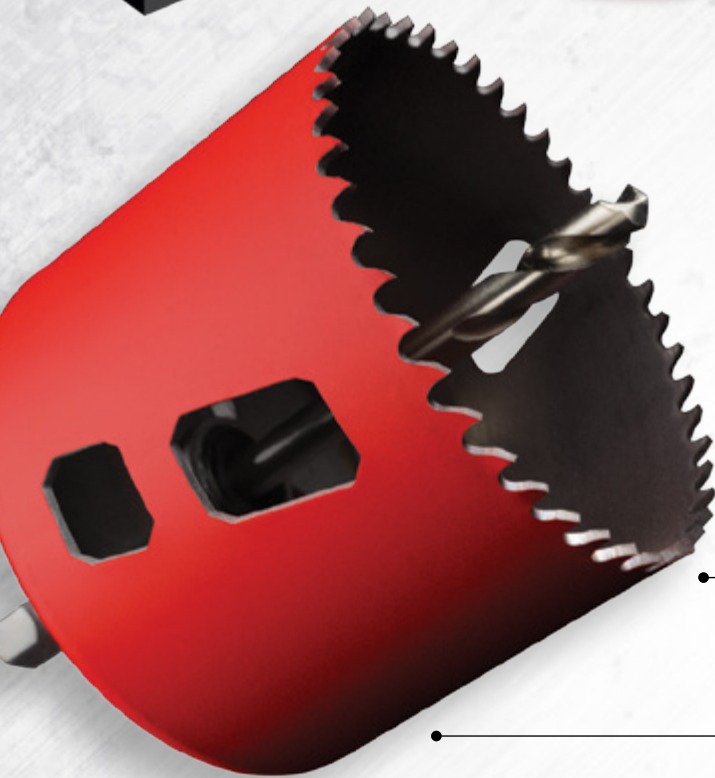

Optimized new teeth, designed to remove material faster

New coating reduces side wall friction for efficient cutting

Holesaw Mandrel

Durable, heavy-duty carbon steel mandrel's come complete with pilot drills. Adapt Morse hole saws to any power drill used by professionals.

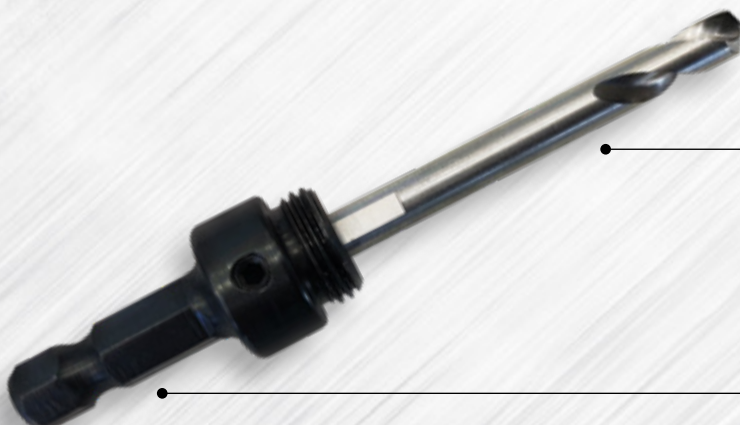

Various shank sizes available from 3/8" or 1/2" drills

Hex arbors with non-slit jaw slots



HOLESAWS

HSS HOLESAW



PART N°	QF	SIZE (mm)	QTY
26HS14	I0841	14	1
26HS16	I0844	16	1
26HS19	I0847	19	1
26HS20	I0848	20	1
26HS22	I0849	22	1
26HS25	I0850	25	1
26HS29	I0851	29	1
26HS32	I0852	32	1
26HS35	I0853	35	1
26HS38	I0854	38	1
26HS41	I0855	41	1
26HS44	I0856	44	1
26HS46	I0857	46	1
26HS51	I0858	51	1
26HS57	I0859	57	1
26HS60	I0860	60	1
26HS64	I0861	64	1
26HS67	I0862	67	1
26HS70	I0863	70	1
26HS73	I0864	73	1
26HS76	I0865	76	1
26HS83	I0866	83	1
26HS86	I0867	86	1
26HS89	I0868	89	1
26HS92	I0869	92	1
26HS98	I0870	98	1
26HS102	I0836	102	1
26HS105	I0837	105	1
26HS114	I0838	114	1
26HS121	I0839	121	1
26HS127	I0840	127	1
26HS140	I0842	140	1
26HS152	I0843	152	1
26HS168	I0846	168	1

TCT PF HOLESAW



PART N°	SIZE (mm)	QTY
26TCT40-PF	40	1
26TCT50-PF	50	1
26TCT54-PF	54	1
26TCT60-PF	60	1
26TCT64-PF	64	1
26TCT82-PF	82	1
26TCT86-PF	86	1
26TCT92-PF	92	1
26TCT102-PF	102	1
26TCT114-PF	114	1
26TCT140-PF	140	1

Multiple carbide grits permanently bonded to the cutting edge allow for penetration through cement sheet

REMGRIT HOLESAW



PART N°	QF	SIZE (mm)	QTY
26RG20	I0886	20	1
26RG25	I0887	25	1
26RG32	I0888	32	1
26RG44	I0889	44	1
26RG51	I0890	51	1
26RG60	I0891	60	1
26RG70	I0892	70	1
26RG83	I0893	83	1
26RG92	I0894	92	1
26RG95	I0895	95	1
26RG114	I0885	114	1

Tungsten carbide tooth tips offer the highest wear resistance possible for fast holes and longer life when cutting abrasive materials. Cutting depth is 1-1/2". Arbor required.

TCT HOLESAW



PART N°	QF	SIZE (mm)	QTY
26TCT21	I0944	21	1
26TCT25	I0945	25	1
26TCT32	I0946	32	1
26TCT41	I0949	41	1
26TCT44	I0950	44	1
26TCT48	I0951	48	1
26TCT51	I0952	51	1
26TCT54	I0953	54	1
26TCT57	I0954	57	1
26TCT60	I0955	60	1
26TCT64	I0956	64	1
26TCT67	I0957	67	1
26TCT70	I0958	70	1
26TCT76	I0959	76	1
26TCT86	I0960	86	1
26TCT89	I0961	89	1
26TCT92	I0962	92	1
26TCT102	I0940	102	1
26TCT114	I0941	114	1
26TCT127	I0942	127	1
26TCT152	I0943	152	1

HSS HOLESAW KIT



PART N°	QF	DESCRIPTION	QTY
26HSPLUM10	I0878	PLUMBERS	1
26HSELEC	I0871	ELECTRICIAN	1



HOLESAW MANDREL



PART N°	QF	TO SUIT	QTY
26HSMU	I0874	<30MM	1
26HSMH	I0872	>32MM	1

HOLESAW PILOT DRILL



PART N°	QF	DESCRIPTION	QTY
26HSPS	I0879	SHORT	1
26HSPL	I0876	LONG	1
26TCTPS	I0964	SHORT TCT	1

HOLESAW EXTENSION



PART N°	QF	LENGTH (mm)	TO SUIT	QTY
25DSPEXT	I0875	300	26HSMU	1
26HSMH EXT	I0873	300	26HSMH	1

HOLESAW FAST ADAPTER MANDREL



PART N°	QF	DESCRIPTION	QTY
26MQRAC	I0883	MANDREL	1
26MQRPCD	I0884	PILOT	1

HOLESAW FAST ADAPTER



* Please Note: Pack of 5

PART N°	QF	DESCRIPTION	QTY
26MQR12C	I0881	<30MM	1
26MQR58C	I0882	>32MM	1

ADJUSTABLE HOLECUTTER



PART N°	QF	SIZE (mm)	QTY
26HC230	I0835	30 - 230	1

DUST BOWL



PART N°	QF	QTY
26DUSTB	I0833	1





CUT OFF WHEELS

METAL CUT-OFF WHEEL ULTRA THIN



PART N°	QF	SIZE (mm)	THICKNESS (mm)	HOLE SIZE (mm)	QTY
23102010	I0314	100	1	16	100
23115010	I0315	115	1	22	25
23125010	I0316	125	1	22	25
23230020	I0317	230	2	22	25

METAL CUT-OFF WHEEL



PART N°	QF	SIZE (mm)	THICKNESS (mm)	HOLE SIZE (mm)	QTY
23AC23022	I0323	230	2.5	22	50
23AC30020	I0324	300	3.4	20	50
23AC30025	I0325	300	3	25.4	20
23AC35020	I0326	350	3.8	20	20
23AC35025	I0327	350	3	25.4	10
23AC40020	I0328	400	4.4	20	25
23AC40025	I0329	400	3	25.4	25

INTERNAL PIPE CUTTER

INTERNAL PIPE CUTTER



PART N°	QF	DESCRIPTION	QTY
23INTPC	I0433	-	1
23INTPCW	I0434	WHEEL ONLY	1

GRINDING WHEELS

METAL GRINDING WHEEL



PART N°	QF	SIZE (mm)	THICKNESS (mm)	HOLE SIZE (mm)	QTY
23AG10016	I0330	100	6	16	50
23AG11522	I0331	115	6	22	50
23AG12522	I0332	125	6	22	50
23AG180	I0333	180	6	22	25
23AG230	I0334	230	6	22	10

DIAMOND BLADES

DIAMOND BLADE - TURBO



PART N°	QF	SIZE (mm)	QTY
23DBT100	I0418	100	1
23DBT115	I0419	115	1
23DBT125	I0420	125	1
23DBT230	I0421	230	1

DIAMOND BLADE - DEMO SAW

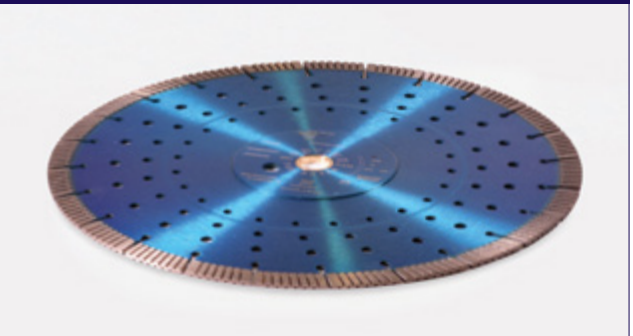

PART N°	QF	SIZE (mm)	QTY
23DBD350	I0416	350	1
23DBD400	I0417	400	1

SAW BLADES

METAL DRY CUT BLADE



PART N°	QF	SIZE (mm)	HOLE SIZE (mm)	QTY
25EM1362030	I0648	135	20	1
25EM1652040	I0650	165	20	1
23RHC300	I0651	305	25.4	1
25EM3502564	I0652	355	25.4	1

FLAP DISCS

ABRASIVE FLAP DISC



PART N°	QF	SIZE (mm)	FINISH	HOLE SIZE (mm)	QTY
23FDISC10040	I0423	100	40G	16	10
23FDISC10060	I0424	100	60G	16	10
23FDISC10080	I0425	100	80G	16	10
23FDISC100120	I0422	100	120G	16	10
23FDISC11540	I0426	115	40G	22	10
23FDISC11560	I0427	115	60G	22	10
23FDISC11580	I0428	115	80G	22	10
23FDISC12540	I0430	125	40G	22	10
23FDISC12560	I0431	125	60G	22	10
23FDISC12580	I0432	125	80G	22	10
23FDISC125120	I0429	125	120G	22	10

TIMBER CIRCULAR SAW BLADE



PART N°	QF	SIZE (mm)	HOLE SIZE (mm)	QTY
25TKR1602040T	I0820	160	16/20	1
25TKR1802040T	I0821	180	16/20	1
25TKR2352540T	I0824	235	25.4	1

EXACTCUT SAW BLADE



PART N°	QF	SIZE (mm)	QTY
25EXACTTCTBL-140	I0653	160	1
25EXACTTCTBL-165	I0654	180	1

WIRE WHEELS

TWIST KNOT WIRE WHEEL



PART N°	QF	SIZE (mm)	THREAD SIZE	QTY
23TKW-W115M14	I0442	115	M14	1
23TKW-W125M14	I0443	125	M14	1

SANDPAPER

EMERY PAPER



PART N°	QF	SIZE (mm)	FINISH	QTY
23SPE60	I0438	50	60G	1
23SPE80	I0439	50	80G	1



RECIPRO BLADES

GENERAL PURPOSE 10 - 14 TPI RECIPRO BLADE



PART N°	QF	LENGTH (mm)	QTY
26RB10T150	I0774	150	1
26RB10T200	I0775	200	1
26RB10T300	I0776	300	1

TCT RECIPRO BLADE



PART N°	QF	LENGTH (mm)	QTY
26RB150TCT	I0778	150	1

METAL 24 TPI RECIPRO BLADE



PART N°	QF	LENGTH (mm)	QTY
26RB24T150	I0782	150	1

REMGRIT RECIPRO BLADE



PART N°	QF	LENGTH (mm)	QTY
26RB150RG	I0777	150	1

METAL 18 TPI RECIPRO BLADE



PART N°	QF	LENGTH (mm)	QTY
26RB18T100	I0779	150	1
26RB18T150	I0780	225	1
26RB18T300	I0781	300	1

WOOD 6 TPI RECIPRO BLADE



PART N°	QF	LENGTH (mm)	QTY
26RB6T150	I0783	150	1
26RB6T230	I0784	225	1
26RB6T300	I0785	300	1

JIGSAW BLADES

JIGSAW BLADE - METAL



PART N°	QF	TO SUIT	QTY
25T118A	I0817	Metal	1

JIGSAW BLADE - WOOD



PART N°	QF	TO SUIT	QTY
25T144D	I0818	Wood	1



HACKSAW BLADE

HACKSAW BLADE



PART N°	QF	TPI	QTY
25BI18	10640	18	10
25BI24	10641	24	10
25BI32	10642	32	10

MULTI TOOL BLADE

MULTI TOOL BLADE - GENERAL PURPOSE



PART N°	QF	QTY
232608661644	10318	1

KNIVES AND BLADES

HACKING KNIFE



PART N°	QF	QTY
25HK	10658	1

SNAP OFF KNIFE



PART N°	QF	QTY
25655-1	10633	1

SNAP OFF BLADES



PART N°	QF	SIZE (mm)	QTY
25KB201	10744	18	1

RETRACTABLE TRIMMING KNIFE



PART N°	QF	QTY
25690	10634	1

TRIMMING KNIFE BLADES - 100PK



PART N°	QF	QTY
25TRIB100	10826	1

TRIMMING KNIFE BLADES - 10PK



PART N°	QF	QTY
25TRIB10	10825	1

PREMIUM LAGGING KNIFE



PART N°	QF	QTY
25H-12YE-3B	10655	1

PREMIUM LAGGING KNIFE BLADES - 10PK



PART N°	QF	QTY
25HB-10BH	10657	1



CAULKING GUNS

CAULKING GUN - HEAVY DUTY



PART N°	QF	QTY
20DSG300HD	J0200	12

SAUSAGE GUN



PART N°	QF	QTY
20DSG500	J0202	1

CAULKING GUN - LIGHT DUTY



PART N°	QF	QTY
20DSG300	J0201	24

SAUSAGE GUN NOZZLE



PART N°	QF	QTY
20DSGN02	J0203	10

SOLDERING TOOLS

MAPP GAS KIT



PART N°	QF	QTY
30GAS-TORCH	J0488	1

MAPP GAS BOTTLE



PART N°	QF	QTY
40MAPPGAS	I1205	12

REPLACEMENT FLINTS



* Please Note: Packs of 10

PART N°	QF	QTY
30FSP10	I1204	1

FLINT GUN



PART N°	QF	QTY
30FG01	J0487	1



DUCT TOOLS

J CLEAT TOOL



PART N°	QF	QTY
33JCT	D1094	1

DUCT CRIMPING TOOLS



PART N°	QF	DESCRIPTION	QTY
37DC5	J0593	STRAIGHT	1
37DC6	J0594	OFFSET	1

BROOMS

BROOM HEAD - GENERAL PURPOSE



PART N°	QF	QTY
37BROOM600-GP	J0587	1

BROOM HANDLE



PART N°	QF	SIZE (mm)	QTY
37BHANDLE25	J0581	25	1

DUST PAN AND BROOM SET



PART N°	QF	QTY
37DUSTPAN	J0595	1

SPANNERS AND SOCKETS

1/2 DRIVE SOCKET



PART N°	QF	SIZE (mm)	QTY
37TEQ1213	J0648	13	1
37TEQ1216	J0650	16	1
37TEQ1217	J0651	17	1
37TEQ1218	J0652	18	1
37TEQ1219	J0653	19	1
37TEQ1220	J0654	20	1
37TEQ1221	J0655	21	1

1/2 DRIVE SOCKET DRIVER



PART N°	QF	QTY
37TEM0112	J0646	1

ADJUSTABLE SPANNER



PART N°	QF	QTY
379031	J0574	1

STAR PICKET TOOL



PART N°	QF	QTY
27START	J0460	1



GENERAL TOOLS

COMBINATION PLIERS



PART N°	QF	QTY
373800-CTV	J0571	1

HAND RIVETING TOOL



PART N°	QF	QTY
09DRT10	J0176	1

WIRE BRUSH



PART N°	QF	QTY
30WB	J0560	1

TIN SNIPS - WISS



PART N°	CUT	QTY
37TSR	LEFT	1
37TSG	RIGHT	1

CABLE TIE TENSIONERS

CABLE TIE TENSIONER - LIGHT DUTY



PART N°	QF	QTY
36LDCTG	J0563	1

HACKSAW FRAME



PART N°	QF	QTY
25HF	J0343	1

PAINT SCRAPER



PART N°	QF	SIZE (mm)	QTY
37PSCRA100	J0639	100	12
37PSCRA125	J0640	125	12
37PSCRA150	J0641	150	12
37PSCRA50	J0642	50	12

TIN SNIPS - MIDWEST

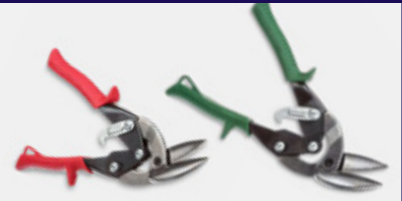

PART N°	CUT	QTY
37MWP6510L	LEFT	1
37MWP6510R	RIGHT	1

HAND FILE



PART N°	QF	DESCRIPTION	LENGTH (mm)	QTY
30101213	J0476	1/2 BASTARD	300	1
30101223	J0477	1/2 2ND CUT	300	1
30301213	J0478	RND BASTARD	300	1

TAPE MEASURES



PART N°	QF	LENGTH	QTY
398TMM	J0572	8MTR	1
398TMMAG	J0573	8MTR MAGNETIC	1

TIN SNIPS YELLOW - STRAIGHT CUT



PART N°	QF	QTY
37TSY	J0659	1

CABLE TIE TENSIONER - HEAVY DUTY



PART N°	QF	QTY
36HDCTG	J0561	1

CABLE TIE TENSIONER - STAINLESS STEEL



PART N°	QF	QTY
36HDCTGSS	J0562	1



PLATFORM LADDERS

FIBREGLASS PLATFORM LADDER



PART N°	QF	SIZE (mm)	WORKING LOAD (kg)	QTY
39T332104	J0516	1200	150	1
39T332105	J0522	1500	150	1
39T332106	J0529	1800	150	1

ALUMINIUM PLATFORM LADDER



PART N°	QF	SIZE (mm)	WORKING LOAD (kg)	QTY
39T331102	J0501	600	150	1
39T331103	J0506	900	150	1
39T331104	J0513	1200	150	1
39T331105	J0519	1500	150	1
39T331106	J0526	1800	150	1



STORAGE EQUIPMENT

EXACTAPAK COMPARTMENT CASE



PART N°	QF	QTY
30EXACTAPAK	J0484	1

FIXED CASTOR



PART N°	QF	QTY
30FCASTOR	J0485	1

SWIVEL CASTOR



PART N°	QF	QTY
30SCASTOR	J0546	1

MULTI-10 COMPARTMENT CASE



PART N°	QF	QTY
30MULTI	J0497	1

WELDED CHAIN

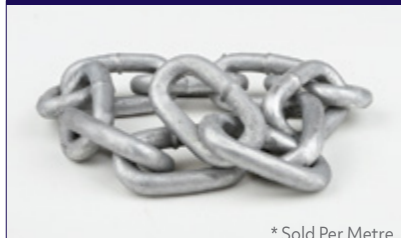

* Sold Per Metre

PART N°	QF	SIZE (mm)	QTY
30CHAIN05G	-	5	1
30CHAIN08G	I1184	8	1
30CHAIN10G	I1183	10	1

PADLOCK

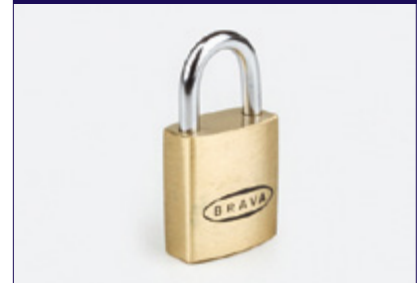

PART N°	QF	SIZE (mm)	QTY
30PADLOCK25KA	J0499	25	12
30PADLOCK45KA	J0500	45	1



ACURA STORAGE SOLUTIONS

SITE BOX



PART N°	QF	PART N°	QTY
39SB720	J0557	Standard Site Box	1
39SB850	J1029	Large Site Box	1

Keep your tools with you on site, and keep them safe with the Acura sitebox.

These versatile units can be used as a delivery unit but double up equally well as a lockable site box, ensuring the safety of your tools and any other expensive personals or supplies you might have on site.

Site Box Approximate Internal Measurements

Length	Width	Height
1095mm	520mm	550mm

Large Site Box Approximate Internal Measurements

Length	Width	Height
1095mm	680mm	700mm

ARMORGARD SOLUTIONS

ARMORGARD SITESTATION SS2



PART N°	DESCRIPTION	QTY
39AGSS2	Armorgard SiteStation SS2	1

Finally - a purpose-built solution to your on site work station needs

The SiteStation gives you a convenient place for performing routine on site tasks, while also providing secure storage for your valuable equipment like power tools, PPE and fixings.

- Split into two compartments with separate lockable doors. Both compartments contain full width shelving for easy organisation of contents.
- Slanted working shelf in top section also acts as a lockable lid for the compartment behind.
- Ideal for storing anything from PPE to fixings and power tools.
- Allows project managers to stay close to the work and workers on site, while reducing the requirement for temporary site offices.
- Robust design and 5-lever deadlocks ensure the SiteStation is secure.
- LED work light and 2x 110V sockets are built in.
- Lifting eyes, fork pockets and castors mean the unit is very mobile and easy to move around site.
- Weather resistant rubber gaskets around the openings help prevent water ingress.

Armorgard SiteStation External Measurements & Weight

Depth	Width	Height	Weight
800mm	1400mm	1970mm	223kg

Armorgard SiteStation Top Internal Measurements

Depth	Width	Height
800mm	1300mm	1065mm

Armorgard SiteStation Bottom Internal Measurements

Depth	Width	Height
800mm	1300mm	610mm

ARMORGARD CUTTINGSTATION SS7



A go-anywhere, multi-purpose cutting station with unrivalled safety features to minimise vibration, sparks, noise and dust.

The Armorgard CuttingStation is a neat, mobile workstation that eliminates the need for a separate cutting room and is essential for safely cutting lengths, such as conduit, timber, cable tray and pipe.

The SS7 model improvements include new lighting and chamfered corners to further reduce noise. You'll also find a new expandable working area to accommodate mitre saws and cutaway sides for handling longer lengths.



- A multi-purpose cutting platform, with a secure cabinet beneath the workbench area
- Recessed 240V inlet power supply 2 x 240V internal sockets
- Extendable support arms with 4 configurations
- Heavy-duty all-swivel wheels for easy moving
- Extendable back panel provides extra workspace for mitre saws
- Sound deadening fire-rated foam to reduce noise pollution
- Rubber mat to reduce vibration
- Rubberised wheels for reduced vibration
- PVC curtains to contain sparks
- Secure cabinet to keep your tools safe
- Swarf collector with dust extractor connection point
- Improved lighting position for increased productivity

Armorgard CuttingStation External Measurements & Weight

Depth	Width	Height	Weight
780mm	1390mm	1900mm	175kg

Armorgard CuttingStation Top Internal Measurements

Depth (ext. back)	Width	Height
955mm	1125mm	1000mm

Armorgard CuttingStation Bottom Internal Measurements

Depth	Width	Height
710mm	1125mm	550mm

PART N°	DESCRIPTION	QTY
39AGSS7	Armorgard CuttingStation SS7	1



ARMORGARD PIPERACK PR1



PART N°	DESCRIPTION	QTY
39AGPR1	Armorgard PipeRack PR1	1

The adaptable mobile on-site pipe and conduit storage solution.

The Armorgard PipeRack is an innovatively designed wheeled storage rack that keeps pipes and strut organised and easy to manoeuvre while you're working on site.

PipeRack is available with a 1 tonne capacity, or can be upgraded to a 2 tonne capacity with an optional upgrade kit.

- Mobile rack for storing copper pipe, conduit etc.
- Unique fold down design allowing them to be stacked up to 6 units high.
- Heavy-duty construction built to be put to the test.
- Piperacks can be linked together to cater for longer lengths, using the Armorgard Linking Kit.
- Can be linked together to hold 6 meter lengths of material.

Armorgard PipeRack Measurements & Weight			
Depth	Width	Height	Weight
1565mm	1010mm	1570mm	83kg
Armorgard PipeRack Folded Measurements			
Depth	Width	Height	
1565mm	1010mm	550mm	

ARMORGARD FITTINGSTOR FC6



PART N°	DESCRIPTION	QTY
39AGFC6	Armorgard FittingStor FC6	1

The storage cabinet designed to help keep your tools safe on site.

FittingStor is designed to secure all your costly M&E components and tools in one safe, easily portable location.

Featuring adjustable shelves, removable fittings bins and heavy duty castors for ease of movement, this innovative product is in high demand among site contractors.

- 5-level deadlocks - top and bottom for maximum security.
- Robust steel plate construction, and powder coated for maximum durability
- Includes 3 sturdy reinforced adjustable shelves.
- Forklift skids are built in for easy transportation.
- Heavy duty industrial castors fitted as standard.

Armorgard FittingStor FC6 Ext. Measurements & Weight			
Depth	Width	Height	Weight
775mm	1077mm	1880mm	123kg
Armorgard FittingStor FC6 Internal Measurements			
Depth	Width	Height	
709mm	880mm	1592mm	

ARMORGARD PIPESTOR PS3 / PS6



PipeStor PS6

PART N°	DESCRIPTION	QTY
39AGPS6	Armorgard PipeStor PS6	1

Armorgard PipeStor PS6 External Measurements & Weight

Depth	Width	Height	Weight
6410mm	575mm	785mm	256kg

Armorgard PipeStor PS6 Internal Measurements

Depth	Width	Height
6350mm	495mm	495mm

The mobile secure storage trunk that keeps your copper piping safe and organised.

Foil the copper thieves by keeping your valuable piping locked up on site in this innovatively designed 'copper coffin'.

The PipeStor portable secure storage trunk, gives you the peace of mind that your copper piping is safe 24/7.

The interior is divided into four sections to accommodate different sizes and styles of pipes – including plastic and metal conduit, trunking and cable tray – and is secured on one end with a heavy-duty door and lock.

Versatile design, it can be easily extended to take longer lengths of pipe by adding optional extra sections as required.

- Mobile unit, designed to keep long lengths of pipe and conduit safe and secure.
- Robust steel plate construction and finished in a durable powder coat.
- Internally divided into 4 separate compartments which maximises the storage capacity and maintains tidiness within the unit.
- Supplied in 1.5m lengths which are bolted together.
- Fork skids for easy transportation.

ARMORGARD MOBILE TUFFBENCH BH1270M-W



Engineers vice and chain vice not included.

PART N°	DESCRIPTION	QTY
39AGBH1270M-W	Armorgard Mobile TuffBench Wooden Top	1

Armorgard Mobile TuffBench Ext. Measurements & Weight

Depth	Width	Height	Weight
700mm	1200mm	940mm	97.5kg

Armorgard Mobile TuffBench Int. Measurements & Weight

Depth	Width	Height
630mm	990mm	640mm

The universal mobile workbench that's also a heavy-duty cabinet!

Use the Armorgard Mobile TuffBench™ for a day and you'll wonder how you ever got by without it.

A combination of heavy-duty storage cabinet and multi-purpose work surface, this innovative workbench makes any job that bit easier, while ensuring that your tools and equipment remain safe from thieves and damage.

Its ultra-tough surface is ideal for fixing chain vice, engineers vice and other equipment, making it indispensable for M&E contractors when pipe threading and bending.

- Fitted with wooden top, making it indispensable for M&E contractors.
- Secure cabinet section beneath the workbench to lock away tools and equipment.
- Safe working load of 1000kg.
- Powder coated with anti-corrosive undercoat.
- Fitted with extra heavy-duty wheels, to make it easier to manoeuvre on site.
- Handles fitted to each end of the unit to make it easier to move.

Can be used with engineers vice or a chain vice (not included).



◆ Index





Index

CONTENTS	PAGE
A - C	176
C - H	177
H - P	178
P - S	179
S - Z	180



A	
ABRASIVE FLAP DISC	163
AC100E	107
ACETONE	130
ACRYLIC GAP FILLER	128
ACURA STORAGE SOLUTIONS	170
ADHESIVES	129
ADJUSTABLE ALLTHREAD CLIPS	33
ADJUSTABLE ALLTHREAD CLIPS - POWDER COATED	33
ADJUSTABLE BEAM CLAMP	15
ADJUSTABLE MOUNT - ASRM100 - SUPERMOUNT	83
ADJUSTABLE MOUNT - ASRM40 - SUPERMOUNT SLIDE-IN	83
ADJUSTABLE MOUNT - ASRM50 - SUPERMOUNT	83
ADJUSTABLE MOUNT - ASRM75 - SUPERMOUNT	83
ADJUSTABLE SPANNER	167
ADJUSTABLE STAND OFF BRACKET	38
A-ISOL INSULATION FIXING	113
ALCOHOL WIPES	130
ALLTHREAD - GALVANISED	23
ALLTHREAD - STAINLESS STEEL	23
ALLTHREAD - ZINC	23
ALLTHREAD STUBS - ZINC	23
ALUMINIUM PLATFORM LADDER	169
ALUMINIUM TAPE - PLAIN	129
ALUMINIUM TAPE - REINFORCED	129
ALUMINIUM RIVET - ALUMINIUM BODY WITH STEEL STEM	125
AMBER SAFETY GLASSES	137
ANGLE	23
ANGLE BRACE - 45°	13
ANGLE BRACKET - 2 HOLE	13
ANGLE BRACKET - 3 HOLE	13
ANGLE BRACKET - 4 HOLE	13
ANGLE BRACKET - 4 HOLE BRACED	13
ANGLE BRACKET LIGHT DUTY	25
ANGLE BRACKETS	13
AQUASEAL	62
ARMORGARD CUTTINGSTATION S57	171
ARMORGARD FITTINGSTOR FC6	172
ARMORGARD MOBILE TUFFBENCH BH1270M-W	173
ARMORGARD PIPERACK PR1	172
ARMORGARD PIPESTOR PS3 / PS6	173
ARMORGARD SITESTATION S52	170
ARMORGARD SOLUTIONS	170
AT3 CABLE TRAY	92
AT3 CABLE TRAY & ACCESSORIES	92
AT3 CABLE TRAY HOLD DOWN BRACKETS	92
AT3 CABLE TRAY JOINER BOLTS AND NUTS	92
AT3 CABLE TRAY RADIUS PLATES	92
AT3 CABLE TRAY RISER PLATES	92
AT3 CABLE TRAY SPLICE PLATES	92
AT3 CABLE TRAY TEE CROSS BRACKET	92
AT3 FIRE RATED CABLE TRAY	94
AT3 FIRE RATED CABLE TRAY HANGER KITS	95
AT3 FIRE RATED CABLE TRAY HANGERS	95
AT3 FIRE RATED CABLE TRAY HOLD DOWN BRACKETS	95
AT3 FIRE RATED CABLE TRAY SPLICE KITS	95
AT3 FIRE RATED CABLE TRAY SPLICE PLATES	95
AT3 FIRE RATED CABLE TRAY TRAPEZE KITS	95
AT5 CABLE TRAY & ACCESSORIES	93
AT5 CABLE TRAY COVERS	93
AT5 CABLE TRAY HOLD DOWN BRACKETS	93
AT5 CABLE TRAY RADIUS PLATES	93
AT5 CABLE TRAY RISER PLATES	93
AT5 CABLE TRAY SPLICE PLATES	93
AT5 CABLE TRAY TEE CROSS BRACKET	93
AT5 FIRE RATED CABLE TRAY	94
AT5 FIRE RATED CABLE TRAY SPLICE KITS	95
AUGER BIT	158
AUGER BITS	158
B	
BACK TO BACK STRUT	11
BACK TO BACK STRUT BASE PLATE	14
BACKER ROD	129
BANG-IT	103
BAR GUARD CAP	139
BARRICADE MESH	139
BARRIER STRIP FOR STRUT CLIPS	41
BASE PLATES	14
BASKET TRAY CLAMP	90
BATTERIES	135
BEAM CLAMP	24
BEAM CLAMP LIGHT DUTY	24
BEAM CLAMP WIDE MOUTH	24
BEAM CLAMPS	24
BENCH	173
BIG BLU SPRAY	130
BIG RED WELDING GLOVES	134
BLACK KNIGHT GLOVES	136
BLACK POLY FILM	133
BLOW PUMP	144
BOLTS	114
BOSS P40-MAK WRAP	51
BRACED CANTILEVER BRACKETS	12
BRACKET	25/38
BRACKET HANGER	38
BRACKET LIGHT HANGING	38
BRACKET STAND OFF	37/38
BRACKET STAND OFF T-BRACKET	38
BRACKETS	13
BRACKETS U SHAPE	15
BROOM HANDLE	167
BROOM HEAD - GENERAL PURPOSE	167
BROOMS	167
BUGLE BATTEN SCREW	125
BUGLE HEAD DRILLPOINT SCREW	121
BUGLE HEAD NEEDLEPOINT SCREW	124
BUILDING PRODUCTS	135
BUTTERFLY NUT	12
BUTTON HEAD DRILLPOINT SCREW - CLASS 2	121
BUTTON HEAD DRILLPOINT SCREW - CLASS 3	121
BUTTON HEAD NEEDLEPOINT SCREW	124
C	
C1 TSM SCREW ANCHOR	102
C2 SCREW ANCHOR ROD HANGER	102
CABLE MESH BASKET	96
CABLE TIE - PLASTIC	114
CABLE TIE - STAINLESS STEEL	114
CABLE TIE TENSIONER - HEAVY DUTY	168
CABLE TIE TENSIONER - LIGHT DUTY	168
CABLE TIE TENSIONER - STAINLESS STEEL	168
CABLE TIE TENSIONERS	168
CABLE TIES	114
CANTILEVER BRACKETS	12
CARPENTER PENCIL	131
CAST-IN COLLAR EXTENSION TOP	48
CAST-IN COLLARS	48
CAST-IN SHELLS	48
CATENARY WIRE	29/96
CATENARY WIRE COATED	29
CAULKING GUN - HEAVY DUTY	166
CAULKING GUN - LIGHT DUTY	166
CAULKING GUNS	166
CAVITY FIXINGS	109
CENTRE MOUNTING PLATE	24
CENTRE MOUNTING PLATE MALE THREAD	24
CHAIN	29
CHALK	133
CHALK REEL	133
CHEM CAP STUD - GALVANISED	107
CHEM CAP STUD - ZINC	107
CHEMICAL ANCHOR TOOLS	144
CHEMICAL ANCHORS	107
CHEMSET MIXER NOZZLE	108
CHIPBOARD SCREW	124
CLEAR SAFETY GLASSES	137
CLEAR VINYL TUBING	81
CLEVIS HANGER	25
CLIP HEAD	35
CLIP HEADS	38
CLIPS & SADDLES	97
CLM SEISMIC MOUNT HOUSING	83
CLOUTS	120
COATED CATENARY WIRE ROPE	29
COBRA CONTRACTOR PACK	111
COBRA DXG3000 ADAPTER CORD	146
COBRA DXG3000 BATTERY	146
COBRA DXG3000 CHARGER BASE	146
COBRA DXG3000 GAS TOOL	146
COBRA DXG3000 GAS TOOL POLE	146
COBRA FUEL CELL	110
COBRA GAS TOOLS	146
COBRA M10 HANGER	111
COBRA MOUNT	97/111
COBRA PINS AND FUEL CELL	110
COBRA V CONTRACTOR PACK	111
COBRA V FUEL CELL	110
COBRA V GAS TOOL	146
COBRA V PINS AND FUEL CELL	110
COBRA V ZIP CONTRACTOR PACK	111
COBRA ZIP CABLE TIE	111
COBRA ZIP CONTRACTOR PACK	111
COMBAT CAST-IN COLLARS	48
COMBAT COLLARS	48
COMBINATION PLIERS	168
CONCRETE INSERTS	103
CONCRETE SCREW ANCHORS	102
CONDUIT	97
CON-LOCK ENDS	96
CON-LOCK FXINGS	96
CONSTRUCTION ADHESIVE	129
COPPER CLIP HEAD	38
COPPER PAIR COIL - REFRIGERATION R410A	87
COPPER PIPE SADDLE	42
COPPER PIPE WELDED NUTCLIP - POWDER COATED BROWN	33
COPPER PRESS BRASS FEMALE BARREL UNION	71
COPPER PRESS BRASS FEMALE COUPLER	71
COPPER PRESS BRASS MALE BARREL UNION	71
COPPER PRESS BRASS MALE COUPLER	71
COPPER PRESS BRASS SUPPORT RING	69
COPPER PRESS ELBOW 45°	67
COPPER PRESS ELBOW 90°	67
COPPER PRESS END CAP	67
COPPER PRESS EQUAL TEE	68
COPPER PRESS FITTING REDUCER	68
COPPER PRESS FITTINGS	67
COPPER PRESS REDUCING COUPLING	69
COPPER PRESS SLIP COUPLING	68
COPPER PRESS STRAIGHT COUPLING	68
COPPER PRESS UNEQUAL TEE	69
COPPER PRESS XL ELBOW 45°	75
COPPER PRESS XL ELBOW 90°	75
COPPER PRESS XL END CAP	75
COPPER PRESS XL EQUAL TEE	73
COPPER PRESS XL FITTING REDUCER	74
COPPER PRESS XL FITTINGS	73
COPPER PRESS XL FLANGE ADAPTER	74
COPPER PRESS XL REDUCING COUPLING	74
COPPER PRESS XL ROLL GROOVE ADAPTER	75
COPPER PRESS XL SLIP COUPLING	75
COPPER PRESS XL STRAIGHT COUPLING	75
COPPER PRESS XL UNEQUAL TEE	73
COPPER TUBE	76
COPPER TUBE - REFRIGERATION R410A	76/87
CORDED EAR PLUGS	137
CORNER WING FITTING	15
COUNTERSUNK DRILLPOINT SCREW	121
COUNTERSUNK TYPE 17 SCREW	123
CRAYONS	132
CSM SEISMIC MOUNT HOUSING	83
CUP HEAD BOLT AND NUT	114
CUSHION CLAMP	41
CUSTOM PIPE MARKERS	64
CUT OFF WHEELS	162
CUTTING COMPOUND	131
CUTTING LIQUID	131
CUTTING LUBRICANT PASTE	131



CUTTING LUBRICANTS	131	FIRE RATED CABLE TRAY SPLICE KITS	95
CUTTINGSTATION	171	FIRE RATED FIRESOUND	128
D			
D PURLIN HANGER	25	FIRE RATED FYREFLEX	128
DEGREASER	130	FIRE RATED INSULATION WRAP	51
DENSO TAPE	62	FIRE RATED WEDGE ANCHOR	108
DIAMOND BLADE - DEMO SAW	162	FIRE SEALANTS	51
DIAMOND BLADE - TURBO	162	FIRE SERVICE CLAMPS	36
DIAMOND BLADES	162	FIRE WRAP	51
DIAMOND CORE BITS	155	FIREMASTIC-HPE	51
DIAMOND CORE DRILLS	154	FIREMASTIC-HPE SEALANT	128
DIAMOND GRIT CORE BIT	155	FIRESOUND	51
DIAMOND WET CORE BIT - BSP	155	FIRESOUND SEALANT	128
DIAMOND WET CORE BIT - STRAIGHT	155	FITTINGSTOR	172
DISPOSABLE COVERALLS	138	FIXED CASTOR	169
DISPOSABLE GLOVES	136	FLAG BUNTING	139
DOUBLE SIDED TAPE	130	FLANGE NUT	118
DOUBLE SLIDE GUIDE	31	FLAP DISCS	163
DOUBLE SLIDE GUIDE NO TABS	31	FLAT PLATE - 1 HOLE	14
DOWNPIPE BRACKETS	35	FLAT PLATE - 2 HOLE	14
DRAIN LAGGING	62	FLAT PLATE - 4 HOLE	14
DRILLCUTTA - BUCKET	102	FLAT PLATE FITTINGS	14
DRILLCUTTA SCREW ANCHORS	102	FLAT PLATE RIGHT ANGLE	14
DRILLCUTTA SDS DRILL BIT	152	FLAT PLATE TEE	14
DRILLPOINT SCREWS	121	FLAT RUBBER FOR STRUT CLIPS	41
DRIVE SOCKET 1/2"	167	FLAT TOP DRILLPOINT SCREW - CLASS 2	121
DRIVE SOCKET DRIVER 1/2"	167	FLAT TOP DRILLPOINT SCREW - CLASS 3	121
DROP-IN ANCHOR - BUCKET	100	FLAT TOP NEEDLEPOINT SCREW	124
DROP-IN ANCHOR - STAINLESS STEEL	100	FLAT WASHER - GALVANISED	120
DROP-IN ANCHOR - ZINC	100	FLAT WASHER - STAINLESS STEEL	120
DROP-IN ANCHORS	100	FLAT WASHER - ZINC	120
DROP-IN SDS DRILL BIT	153	FLEXIBLE DUCT STRAPPING	85
DROP-IN SETTING TOOL	144	FLINT GUN	166
DROP-IN SETTING TOOL - HEAVY DUTY	144	FLOOR MOUNT GAS RISER SUPPORTS	30
DROP-IN SETTING TOOLS	144	FLOOR WASTE RETROFIT COLLAR	49
DRY CORE DRILL	154	FOAM SEALED SAFETY GOGGLES	137
DRY CORE DRILL GUIDE ROD	154	FOAM TAPE	85
DRY CORE DRILL M - F EXTENSION	155	FOILFLEX NO-CLAD LAGGING	59
DRY CORE DRILL PILOT DRILL	155	FULL SADDLE	97
DRY CORE DRILL SDS ADAPTER PACK	155	FYREBOX	51
DRY CORE DRILL SDS MAX ADAPTER PACK	155	FYREFLEX	51
DRY CORE DRILL SDS MAX TO BSP ADAPTER	155	FYRESET GROUT	51
DRY CORE DRILL SDS TO BSP ADAPTER	155	FYREWRAP INSULATION	51
DUCT BOLTS	84	G	
DUCT CORNER	29	GALVANISED PIPE SADDLE	42
DUCT CORNER BRACKET	84	GAS COLLARS	49
DUCT CRIMPING TOOLS	167	GAS FIXINGS	110
DUCT HANGER BOLT M10	84	GAS RISER SUPPORTS	30
DUCT HANGERS	84	GENERAL PURPOSE 10 - 14 TPI RECIPRO BLADE	164
DUCT SCREW BOLT M10	84	GENERAL PURPOSE SILICONE	128
DUCT SEALANT	128	GENERAL TOOLS	168
DUCT STRAPPING	85	GIRDER CLAMP	25
DUCT TAPE	130	GIRDER CLIP	97
DUCT TOOLS	167	GLOVE KEEPER CLIP	136
DUCTSHIELD PROTECTIVE FILM	85	GLOVES	136
DUST BOWL	161	GOGGLE FACE SHIELD	137
DUST PAN AND BROOM SET	167	GREY CORRUGATED CONDUIT	97
E			
EAR MUFFS	137	GREY RIGID CONDUIT	97
ECT CABLE TRAY	91	GRINDING WHEELS	162
ECT CABLE TRAY & ACCESSORIES	91	GRIP LOCK	86
ECT CABLE TRAY COVERS	91	GROUT AND CONCRETE	129
ECT CABLE TRAY DIVIDER STRIPS	91	H	
ECT CABLE TRAY HOLD DOWN BRACKETS	91	HACKING KNIFE	165
ECT CABLE TRAY JOINER BOLTS AND NUTS	91	HACKSAW BLADE	165
ECT CABLE TRAY RADIUS PLATES	91	HACKSAW FRAME	168
ECT CABLE TRAY RISER PLATES	91	HALF FACE MASK	138
ECT CABLE TRAY SPLICE PLATES	91	HALF FACE MASK CARTRIDGES	138
ECT CABLE TRAY TEE CROSS BRACKET	91	HALF SADDLE	97
ECT CABLE TRAY TRAPEZE SUPPORTS	91	HALF SHIMS	133
ELECTRICAL CONSUMABLES	97	HAND CLEANER	139
ELECTRICAL TAPE	97	HAND FILE	168
EMBELTON SPRINGS TO SUIT CLM MOUNTS	82	HAND PROTECTION	136
EMBELTON SPRINGS TO SUIT CSM MOUNTS	82	HAND RIVETING TOOL	168
EMBELTON WAFFLE PADS	84	HANGER BOX ACCESSORIES	82
EMERY PAPER	163	HANGER BOX M10 RUBBER ELEMENT	82
ENGINEERING CHALK	133	HANGER BOX RUBBER ELEMENTS	82
EXACTAPAK COMPARTMENT CASE	169	HANGER BOX SPRINGS	82
EXACTCUT SAW BLADE	163	HANGER BOXES	82
EXACTCUT SAW KITS	151	HANGER BOXES WITH RUBBER ELEMENT	82
EXPANDING FOAM	51/128	HANGER BRACKET	38
EXTENSION LEAD HOOK	151	HANGER SUPPORT	25
EXTENSION LEAD HOOKS	151	HANGERS & CLIPS	25
EXTENSION LEADS	151	HARD HAT	136
EXTERNAL ANGLE BRACKET - 45°	13	HARD HAT EAR MUFFS	137
EXTERNAL STRUT BEAM CLAMP	24	HAWKINS PASTE	63
EYE AND FACE PROTECTION	137	HAZARD TAPE	139
EYE BOLT ANCHOR	103	HDPE PIPE WELDED NUTCLIP - POWDER COATED BLACK	32
F			
FACE SHIELD	137	HEAD PROTECTION	136
FBS II SEISMIC ANCHOR ROD HANGER	102	HEADLESS SCREWS	119
FEMALE DRILLCUTTA	102	HEARING PROTECTION	137
FEMALE TEST CAP	62	HEAT RESISTANT SEALANT	128
FERROCRAFT 11	135	HEAVY DUTY CLAMPS	35
FERRULES	43	HEAVY DUTY DOUBLE SLIDE GUIDE	31
FIBREGLASS PLATFORM LADDER	169	HEAVY DUTY DOUBLE SLIDE GUIDE NO TABS	31
FIRE BOXES	51	HEAVY DUTY FOIL FACED NO-CLAD TAPE	59
FIRE COLLAR BAND	49	HEAVY DUTY SINGLE SLIDE GUIDE	31
FIRE COLLARS	49	HEAVY DUTY SINGLE SLIDE GUIDE NO TABS	31
FIRE DAMPER PACKING	51	HEAVY DUTY STRUT BASE PLATE	14
FIRE DAMPER STRIP	51	HEAVY DUTY TOGGLE	113
FIRE EXTINGUISHER - ABE	139	HEAVY DUTY TWO PIECE PIPE CLAMP	35
FIRE EXTINGUISHERS	139	HEX BOLT - STAINLESS STEEL	117
FIRE PILLOW	51	HEX BOLT AND NUT - GALVANISED	116
FIRE PILLOWS	51	HEX BOLT AND NUT - ZINC	115
FIRE RATED BOARD	51	HEX COUPLER	118
FIRE RATED CABLE LADDER	94	HEX NUT - GALVANISED	118
FIRE RATED CABLE LADDER KIT	94	HEX NUT - STAINLESS STEEL	118
FIRE RATED CABLE TRAY	94	HEX NUT - ZINC	118
FIRE RATED CABLE TRAY ACCESSORIES	95	HEX SCREW BOLT - GALVANISED	106
FIRE RATED CABLE TRAY ANGLE BRACKETS	95	HEX SCREW BOLT - ZINC	106
FIRE RATED CABLE TRAY JOINER BOLTS	95	HEX SET SCREW	117
FIRE RATED CABLE TRAY JOINER NUTS	95	HEX SLEEVE ANCHOR - GALVANISED	104
		HEX SLEEVE ANCHOR - STAINLESS STEEL	104
		HEX SLEEVE ANCHOR - ZINC	103
		HIGH FLOOR WASTE CAST-IN COLLAR	48



HIGH PERFORMANCE SILICONE	128
HIGHLIGHTERS	131
HOLE CLEANING BRUSH	144
HOLESAW EXTENSION	161
HOLESAW FAST ADAPTER	161
HOLESAW FAST ADAPTER MANDREL	161
HOLESAW MANDREL	161
HOLESAW PILOT DRILL	161
HOLESAWS	160
HOLLOW SET DROP-IN ANCHOR	100
HOLLOW SET DROP-IN SETTING TOOL	144
HOLLOW WALL ANCHOR	112
HOLLOW WALL ANCHOR SETTING TOOL	144
HOOK SPRING TOGGLE	113
HOSE CLAMPS	81
HOT-DIP GALVANISED STRUT CLIPS	40
HSS DRILL BIT - DOUBLE END	156
HSS DRILL BIT - IMPERIAL	156
HSS DRILL BIT - METRIC	156
HSS DRILL BIT - SINGLE END	156
HSS DRILL BIT SET	156
HSS DRILL BITS	156
HSS HOLESAW	160
HSS HOLESAW KIT	160
HSS REDUCED SHANK DRILL BIT - IMPERIAL	156
HSS REDUCED SHANK DRILL BIT - METRIC	156
HVAC PIPE SUPPORTS	86
HVAC REFRIGERATION PAIR COIL	87
HVAC REFRIGERATION PIPE	87
HWF DRILLPOINT SCREW - CLASS 2	122
HWF DRILLPOINT SCREW - CLASS 3	122
HWF DRILLPOINT SCREW - CLASS 3 NEO	122
HWF DRILLPOINT SERIES 500 SCREW	122
HWF TYPE 17 SCREW - CLASS 2	123
HWF TYPE 17 SCREW - CLASS 3	123
HWF TYPE 17 SCREW - CLASS 3 NEO	123
I	
IBEAMIE LIGHTS	151
INOX LUBRICANT SPRAY	131
INSULATION ADHESIVE	129
INSULATION FIXINGS	113
INTERNAL ANGLE BRACKET - 45°	13
INTERNAL PIPE CUTTER	162
INTERNAL STRUT BEAM CLAMP	24
INTERNAL THREADED TIE WIRE	119
ISOCLIP INSULATED	35
ISOCLIP NON-INSULATED	32
ISOLATION RUBBERS	84
J	
J CLEAT - LONG LEG	85
J CLEAT - UNIVERSAL	85
J CLEAT TOOL	167
J CLEATS	85
JACK CHAIN - ZINC	29
JIGSAW BLADE - METAL	164
JIGSAW BLADE - WOOD	164
JIGSAW BLADES	164
JUMBO CAST-IN COLLAR	48
JUMBO RETROFIT COLLAR	49
K	
KEMFAST CHEMICAL GUN	144
KEVLAR GLOVES	136
KEY TAG	62
KNIVES AND BLADES	165
L	
LAGGING	55
LAGGING NO-CLAD	59
LASERS	151
LIGHT DUTY ANGLE BRACKET	25
LIGHT DUTY WAFFLE PADS	84
LIGHT HANGING BRACKET	38
LIP RUBBER FOR STRUT CLIPS	41
LOCTITE STRING SEAL	63
LOW FLOOR WASTE CAST-IN COLLAR	48
LOXEAL	63
LUMBER CRAYONS	132
M	
MAGNETIC BIT HOLDER	157
MALE DRILLCUTTA	102
MALE THREAD	24
MALTHOID	133
MAPP GAS BOTTLE	166
MAPP GAS KIT	166
MARKERS	131
MARKING CHALK	133
MASK	138
MASKING TAPE	130
MASON RESTRAINED SEISMIC MOUNTS	83
MASONRY PLUGS	108
MAXILITE FIRE RATED BOARD	51
METAL 18 TPI RECIPRO BLADE	164
METAL 24 TPI RECIPRO BLADE	164
METAL CLAMP ROLL STRAP & BUCKLE	81
METAL CUT-OFF WHEEL	162
METAL CUT-OFF WHEEL ULTRA THIN	162
METAL DRY CUT BLADE	163
METAL GRINDING WHEEL	162
METAL NOGGING	62
METAL PIN ANCHOR	108
METAL PIN ANCHORS	108
METAL STRAPPING HOOP IRON	135
METAL STUD PUNCH	142
METAL THREAD	119
METAL THREADS	119
METHYLATED SPIRITS	130
MILWAUKEE 12V COPPER TUBE CUTTER - SKIN ONLY	150
MILWAUKEE 12V SKINS	150
MILWAUKEE 18V 22MM ROTARY HAMMER - SKIN ONLY	147
MILWAUKEE 18V ANGLE GRINDER - SKIN ONLY	147
MILWAUKEE 18V BLOWER - SKIN ONLY	148
MILWAUKEE 18V HACKSAW - SKIN ONLY	148
MILWAUKEE 18V HP AREA LIGHT 3000LU - SKIN ONLY	148
MILWAUKEE 18V LED AREA LIGHT - SKIN ONLY	148

MILWAUKEE 18V LED TORCH - SKIN ONLY	148
MILWAUKEE 18V SKINS	147
MILWAUKEE 18V THREADED ROD CUTTER - SKIN ONLY	148
MILWAUKEE 18V TOOL KITS	150
MILWAUKEE BATTERIES AND CHARGERS	151
MILWAUKEE BATTERY CHARGER 12V - 18V	151
MILWAUKEE BATTERY M12 3.0AH	151
MILWAUKEE BATTERY M18	151
MILWAUKEE FUEL 18V 28MM ROTARY HAMMER - SKIN ONLY	147
MILWAUKEE FUEL 18V CIRCULAR SAW - SKIN ONLY	147
MILWAUKEE FUEL 18V METAL SAW - SKIN ONLY	147
MILWAUKEE FUEL 18V RECIPRO SAW - SKIN ONLY	147
MILWAUKEE FUEL 28MM ROTARY HAMMER M18 5.0AH	150
MILWAUKEE FUEL ANGLE GRINDER M18 5.0AH	150
MILWAUKEE FUEL IMPACT DRIVER M18 5.0AH	150
MILWAUKEE FUEL IMPACT WRENCH M18 5.0AH	150
MILWAUKEE HAMMER DRILL DRIVER M18 4.0AH	150
MILWAUKEE M12 10MM CROWN STAPLER - SKIN ONLY	150
MILWAUKEE PERMANENT MARKERS	131
MIRROR PASTE	63
MKD METAL CLAW ANCHOR	109
MOBILE BENCH	173
MODULAR FRAMING PROMEGA	18
MODULAR FRAMING SIFRAMO	22
MOLYKOTE ANTI SEIZE PASTE	63
MOUNTING PLATES	24
MOUNTING SUPPORTS	87
MSL ANCHOR	109
MUDGUARD WASHER	120
MULTI LASER 7-WAY	151
MULTI TOOL BLADE	165
MULTI TOOL BLADE - GENERAL PURPOSE	165
MULTI-10 COMPARTMENT CASE	169
MULTI-FIX SINGLE STUD HANGER	90
MULTIPIPO GUN 4 IN 1	144
MULTI-PURPOSE LUBRICANT	131
MUNGO MN NYLON PLUG	108
MUNGO MNA NYLON PLUG WITH SCREW DRIVE	108
MUSHROOM HEAD NYLON ANCHOR	110
MUSHROOM HEAD NYLON ANCHOR STAINLESS STEEL	110
MUSHROOM HEAD SPIKE	108
N	
NAIL EYELET ANCHOR	104
NAILS	120
NBR INSULATION	61
NEEDLEPOINT SCREWS	124
NEOPRENE MOUNTS	84
NEOPRENE RUBBER CONDENSER MOUNTS	84
NEOPRENE RUBBER STRUT MOUNTS BOLT ON	84
NEOPRENE RUBBER STRUT MOUNTS SLIDE IN	84
NO-CLAD LAGGING	59
NO-CLAD TAPE	59
NON SHRINK GROUT	129
NOVOPRESS 18V PRESS TOOL - SKIN ONLY	151
NOVOPRESS MINI TOOL KIT	151
NOVOPRESS PRESS TOOLS	151
NOVOPRESS TOOL KIT	151
NUISANCE DUST MASK	138
NUMBER 7 HANGER BRACKET	38
NUT BRACKET WELDED	38
NUT CLIP STAINLESS STEEL	37
NUT SETTER	157
NUTCLIPS RUBBER LINED	35
NUTCLIPS WELDED	32
NUTS	118
NYLOC NUT	119
NYLON ANCHORS	110
NYLON BOLT	115
NYLON NUT	118
O	
ORANGE CORRUGATED CONDUIT	97
ORANGE RIGID CONDUIT	97
ORANGE SWEEP BEND	97
OXY WELDING TIPS	134
P	
P1 TWIN STRAP DUST MASK	138
P2 TWIN STRAP DUST MASK WITH VALVE	138
PA ANGLE CLIP	112
PA CABLE TIE	112
PA CHARGE STRIPS	112
PA FIXINGS	112
PA M10 HANGER	112
PA WASHERED DRIVE PIN	112
PACIFIC MOUNTS	87
PADLOCK	169
PAINT	132
PAINT BRUSHES	132
PAINT MARKERS	131
PAINT SCRAPER	168
PAKAS	133
PAN HEAD DRILLPOINT SCREW	122
PAN HEAD NEEDLEPOINT SCREW	124
PEAR BAND	36
PENCIL	131
PERFORATED CABLE TRAY	96
PERMANENT MARKERS	131
PIPE BRACKET	35
PIPE CLAMP	35
PIPE CUTTERS	142
PIPE CUTTING TOOL	142
PIPE FIRE WRAP	49
PIPE FIRE WRAPS	49
PIPE HANGER ACCESSORIES	33
PIPE HANGERS	33
PIPE MARKERS	64
PIPE RACK	172
PIPE SADDLES	42
PIPE SCISSORS	142
PIPE SEALANTS	63
PIPE STORAGE	173
PIPE TIE	86
PIPE WELDED NUTCLIP - ZINC	32
PIZZA PLATE COVER	133



PLASTER PLUG - METAL	113	SAFETY BOLLARD	139
PLASTER PLUG - NYLON	113	SAFETY GOGGLES	137
PLASTERBOARD FIXINGS	112	SAFETY POWER OUTLET	151
PLASTIC BUILDERS BAG	133	SAFETY SUNGLASSES	137
PLASTIC HALF SADDLE	111	SAFETY VEST	138
PLASTIC HANGERS	86	SANDPAPER	163
PLASTIC PIPE SLEEVES	86	SANITARY SILICONE	128
PLASTIC PLUGS	109	SATINCRAFT 13	135
PLASTIC SIEVE	108	SAUSAGE GUN	166
PLASTIC STUD GROMMET	62/97	SAUSAGE GUN NOZZLE	166
PLATFORM LADDERS	169	SAW BLADES	163
PLUMBING CONSUMABLES	62	SCORPION PLUG	113
PLUMBING LAGGING	62	SCOTCHBRITE PADS	130
POLLIG	62	SCREW BOLTS	106
POLY FERRULES	45	SCREWDRIVER BITS	157
POLY SLEEVE	62	SDS BITS	152
POLY TOGGLE	113	SDS CHISELS	152
POLYBLOCK	45	SDS CHUCK ADAPTER	152
PORTABLE POWER AND LIGHTS	151	SDS DUST CAP	152
POWDER COATED STRUT CLIPS FOR COPPER PIPE	40	SDS MAX CHISELS	152
PREMIUM EAR MUFFS	137	SDS MAX DRILL BIT	153
PREMIUM LAGGING KNIFE	165	SDS MULTI PACK	153
PREMIUM LAGGING KNIFE BLADES - 10PK	165	SDS PLUS DRILL BIT	152
PREMIX CONCRETE	129	SDS PLUS DRILL BIT 4 CUTTER	153
PRESS BRASS FEMALE ELBOW	70	SEALANTS	128
PRESS BRASS FEMALE LUGGED ELBOW W75	70	SEISMIC HEX SCREW BOLT - GALVANISED	107
PRESS BRASS MALE ELBOW	70	SEISMIC HEX SCREW BOLT - ZINC	107
PRESS BRASS MALE LUGGED ELBOW W45	70	SEISMIC MOUNTS	83
PRESS TO CRIMP ADAPTER - PEX	70	SEISMIC RATED CONCRETE SCREW BOLTS	107
PRESS TO CRIMP ADAPTER - PEX MULTILAYER	70	SEISMIC RATED THROUGH BOLT C1 & C2 - ZINC	105
PRESS TO SLIDE SOCKET ADAPTER	70	SEISMIC RATED THROUGH BOLTS	105
PRESSIX 27X27 CHANNEL	16	SEISMIC SCREW ANCHOR ROD HANGER	102
PRESSIX CHANNEL	16	SELF EMBEDDING HEAD DRILLPOINT SCREW	122
PRESSURE PVC CLIP HEAD	38	SELF EMBEDDING HEAD NEEDLEPOINT SCREW	124
PRESSURE PVC COUPLING	80	SIFRAMO BASE PLATE	18
PRESSURE PVC ELBOW - 45°	80	SIFRAMO BEAM SECTION	18
PRESSURE PVC ELBOW - 90°	80	SIFRAMO BEAM SECTION HOLDER	19
PRESSURE PVC END CAP	80	SIFRAMO END CAP	19
PRESSURE PVC FEMALE FAUCET SOCKET	80	SIFRAMO END SUPPORT - 4 HOLE	18
PRESSURE PVC FEMALE FAUCET TAKEOFF ADAPTOR	80	SIFRAMO END SUPPORT - 4 HOLE OFFSET	18
PRESSURE PVC FITTINGS	80	SIFRAMO MODULAR FRAMING	18
PRESSURE PVC MALE VALVE SOCKET	80	SIFRAMO OCTAGONAL COUPLING	18
PRESSURE PVC MALE VALVE TAKE OFF ADAPTOR	80	SIFRAMO PIVOT JOINT	18
PRESSURE PVC PIPE	80	SIFRAMO SELF FORMING SCREW	19
PRESSURE PVC PIPE SADDLE	42	SIFRAMO STRUT ADAPTER	19
PRESSURE PVC REDUCER COUPLING	80	SIFRAMO TORX BIT	19
PRESSURE PVC REDUCING BUSH	80	SIFRAMO U-HOLDER	19
PRESSURE PVC TEE	80	SIFRAMO U-HOLDER - HEAVY DUTY	19
PROTECTIVE FILM	85	SIKAFLEX 11FC SEALANT	128
PUDDLE FLANGE ASSEMBLIES	48	SILICONE	128
PUDDLE FLANGE FLOOR WASTE COLLAR	48	SILICONE SPRAY	130
PULL LINE - 3MM	97	SILVER SOLDER	134
PURE 150 PRO	107	SILVER SOLDER FLUX	134
PURLIN CLEAT - M10	25	SINGLE PIECE CLIP	36
PURLIN CLEAT - M12	25	SINGLE PIECE CLIP STAINLESS STEEL	37
PURLIN CLIP	25	SINGLE SLIDE GUIDE	31
PURLIN D HANGER	25	SINGLE SLIDE GUIDE NO TABS	31
PURLIN HANGER	25	SITE BOX	170
PURLIN HANGER - LIGHT DUTY	25	SITE SAFETY	138
PV45 PRO	107	SITESTATION	170
PVC CLIP HEAD	38	SLEEVE ANCHORS	103
PVC EXPANSION CLIP HEAD	38	SLIDE GUIDES	30
PVC PIPE CEMENT - BLUE	63	SLIDE-IN SUPERMOUNT	83
PVC PIPE CEMENT - CLEAR	63	SLOTTED ANGLE	23
PVC PIPE CEMENT - GREEN	63	SLOTTED STRUT	10
PVC PIPE SADDLE	42	SN SERIES NUT	12
PVC PIPE WELDED NUTCLIP - POWDER COATED WHITE	32	SNAP OFF BLADES	165
PVC PRIMER FLUID - CLEAR	63	SNAP OFF KNIFE	165
PVC PRIMER FLUID - RED	63	SOLAR LAGGING	57
PVC WALL PLUGS	109	SOLATION STRIP FOR STRUT CLIPS	41
Q		SOLDERING TOOLS	166
QB3 EAR PLUGS	137	SOLID ANGLE	22
QUICK CHANNEL	111	SOLID ANGLE - REGISTER	23
QUICK CLIP	111	SOLID STRUT	11
R		SOLVENTS AND CLEANERS	130
RAGS	130	SOUND LAGGING	55
RECIPRO BLADES	164	SPADE BIT	158
RECTANGULAR BACKER ROD	129	SPADE BIT EXTENSION	158
REDBACK CLEANING ABRASIVE	130	SPADE BITS	158
REFRIGERATION CLIPS	41	SPANNERS AND SOCKETS	167
REGISTER SPRING 10X35 PLATED	85	SPEAR BIT	157
REGISTER SPRING 10X75 PLATED	85	SPEAR BITS	157
REGISTER SPRING 10X75 UNPLATED	85	SPEEDNUT STRUT NUT	12
REGISTER SPRING 20X35 UNPLATED	85	SPIKES	108
REGISTER SPRINGS	85	SPOT MARKING PAINT	132
REMGRIT HOLESAW	160	SPRAY PAINT	132
REMGRIT RECIPRO BLADE	164	SPRING HANGER BOX KITS	81
REPLACEMENT FLINTS	166	SPRING HANGER KITS	82
RESPIRATORY PROTECTION	138	SPRING TOGGLE	113
RETRACTABLE TRIMMING KNIFE	165	SPRING WASHER	120
RETROFIT COLLAR	49	SPRINGS	82
RETROFIT COLLARS	49	SQUARE 4 HOLE NEOPRENE RUBBER MOUNTS	84
RIGHT ANGLE DRIVE	157	SQUARE BASE UNBRACED CANTILEVER BRACKETS	12
RIVETS	125	SQUARE DRIVE ADAPTER	157
ROD	23	SQUARE WASHER	14
ROD BRACKET	25	STACK CAST-IN COLLARS	48
ROD CLAMP STUD THREADED	25	STAEDTLER 352 LUMOCOLOR PERMANENT MARKER BULLET TIP	131
ROD CLIPS M10	86	STAINLESS RIVET - STAINLESS BODY WITH STAINLESS STEM	125
ROD CUTTER REPLACEMENT BLADES	142	STAINLESS STEEL CLAMPS	37
ROD LOCK BEAM CLAMP	24	STAINLESS STEEL NUTCLIP	37
ROPE	29	STAINLESS STEEL SINGLE PIECE CLIP	37
ROTARY HAMMER DROP-IN SETTING TOOL	144	STAINLESS STEEL TIMBER AND MASONRY CLIP HEAD	35
ROUND BACKER ROD	129	STAINLESS STEEL TIMBER AND MASONRY PIPE BRACKET	35
ROUND HEAD NYLON ANCHOR	110	STAND OFF BRACKET	37/38
ROUND HEAD NYLON ANCHOR STAINLESS STEEL	110	STAND OFF SADDLE	37
RUBBER ELEMENT	82	STAND OFF SADDLES & BRACKETS	37
RUBBER ISOLATOR WASHER ELEMENT	84	STAND OFF T-BRACKET	38
RUBBER LINED NUTCLIPS	35	STANDARD BATTERIES	135
RUBBER MOUNTS	84	STANDARD PIPE MARKERS	64
RUBBER WASHER ELEMENT	84	STAR PICKET	139
S		STAR PICKET DRIVER TOOL	167
SADDLE	42	STAR PICKET TOOL	167
SADDLE STAND OFF	37	STEEL AND TIMBER VERTIGO SOCKET DRIVER	100



STEEL RIVET - STEEL BODY WITH STEEL STEM	125
STEEL TUBE	24
STEEL WOOL	130
STEP DRILL	156
STIFFENER TUBE	23
STORAGE EQUIPMENT	169
STRING LINE - FLURO	133
STRING LINE - WHITE	133
STRING LINES	133
STRUT	10
STRUT BASE PLATE	14
STRUT BEAM CLAMPS	15
STRUT CLIPS & ACCESSORIES	39
STRUT CLOSURES	16
STRUT COVER	16
STRUT END CAPS	16
STRUT JOINER - EXTERNAL	15
STRUT JOINER - INTERNAL	15
STRUT JOINER TEE	15
STRUT JOINERS	15
STRUT NUT - LONG SPRING	12
STRUT NUT - NO SPRING	12
STRUT NUT - SHORT SPRING	12
STRUT NUTS	12
STUDBITE	90
STUDBITE ACCESSORIES	90
STUDBITE PH2 SCREWS	90
STUDBITE RETROFIT CLAMP	90
SUNSCREEN	139
SUPER WAFFLE PADS	84
SUPERMOUNT	83
SUPERSTRAP DUCT STRAPPING	85
SUSPENSION ANCHORS	104
SUSPENSION ROD BRACKET - 3 HOLE	25
SWIVEL CASTOR	169
T	
TAPE MEASURES	168
TAPE NO-CLAD	59
TAPES	129
TCT HOLESAW	160
TCT PF HOLESAW	160
TCT RECIPRO BLADE	164
TEFLON TAPE	63
TELSTRA ROPE - 6MM	97
TEST TAGS	139
THERMOBREAK LAGGING	57
THERMOLOC	45
THREADED BEAM CLAMP	24
THREADED GIRDER CLAMP	25
THREADED ROD	23
THREADED ROD CLAMP STUD	25
THREADED ROD CUTTER	142
THREADED ROD SLEEVING TUBE	24
THREADED SUPPORT	25
THROUGH BOLT - GALVANISED	105
THROUGH BOLT C1 - ZINC	105
THROUGH BOLTS	105
TIE WIRE ANCHOR	104
TIE WIRE POINT	104
TIE WIRES	119
TIGER TAPE	64
TIMBER CIRCULAR SAW BLADE	163
TIMBER FERRULE	43
TIN SNIPS - MIDWEST	168
TIN SNIPS - WISS	168
TIN SNIPS YELLOW - STRAIGHT CUT	168
T-NUT	12
TOGGLES	113
TOPHAT BASE	87
TOPHAT SET	87
TORCH BATTERY 6V	135
TRAPEZE SUPPORT ADAPTOR	90
TRAPEZE SUPPORTS INSTALL-READY	90
TRIMMER	62
TRIMMING KNIFE BLADES - 100PK	165
TRIMMING KNIFE BLADES - 10PK	165
TSM SEISMIC ANCHOR ROD HANGER	102
TUBE	24
TURNBUCKLE	29
TURPENTINE	130
TWIST CLIP	36
TWIST KNOT WIRE WHEEL	163
TYPE 17 SCREWS	123
U	
U SHAPE BRACKET - 40X20	15
U SHAPE BRACKET - 40X40 / 40X62	15
U SHAPE FITTINGS	15
U-BOLT	36
U-BOLT CLEAT	25
UNBRACED CANTILEVER BRACKETS	12
UNCORDED EAR PLUGS	137
UNICOLLAR	49
UNIVERSAL JOINT	25
V	
VELOX HALF SADDLE - MASONRY NAIL	42
VELOX HALF SADDLE - METAL SCREW	42
VELOX HALF SADDLE - TIMBER SCREW	42
VELPEX GAS FIRE COLLAR	49
VELPRESS JAW KIT 40-50MM	143
VELPRESS JAWS	143
VELPRESS MINI JAWS	143
VELPRESS MINI TOOL KIT 15-32	143
VELPRESS TOOLS	143
VELPRESS XL JAW ADAPTER	143
VELPRESS XL JAW KIT 65-100	143
VELPRESS XL RING JAWS	143
VERTICAL MOUNTING PLATE	24
VERTIGO - HORIZONTAL STEEL	100
VERTIGO - HORIZONTAL TIMBER	100
VERTIGO - VERTICAL STEEL	100
VERTIGO - VERTICAL TIMBER	100
VERTIGOS	100
VIBRATROL COMPACT SERIES HANGER BOX KITS	81

VIBRATROL HEAVY DUTY D-SERIES HANGER BOX KITS	81
VIBRATROL HEAVY DUTY D-SERIES HANGER BOX SPRING KITS	82
W	
WAFFER HEAD DRILLPOINT SCREW	121
WAFFER HEAD TYPE 17 SCREW	123
WAFFLE PADS	84
WALL COLLAR BAND	49
WALL DOG	108
WALL DOGS	108
WALL MOUNT GAS RISER SUPPORTS	30
WASHERS	120
WEDGE NUT	119
WELD COPPER 45° ELBOW S - R	77
WELD COPPER 90° ELBOW S - RT	77
WELD COPPER CONNECTOR	77
WELD COPPER END CAP	77
WELD COPPER EQUAL TEE	77
WELD COPPER REDUCING CONNECTOR	77
WELD COPPER REDUCING CONNECTOR M - F	77
WELD FITTINGS	77
WELDCRAFT	135
WELDED CHAIN	169
WELDED NUT BRACKET	38
WELDED NUTCLIPS	32
WELDING	134
WELDING GLOVES	134
WELDING HELMET	134
WELDING RODS	135
WELDING SPECS SHADE 5	134
WET CORE DRILL	154
WIDE ANGLE TEE BRACKET	13
WINDOW BRACKET BEAM CLAMP	15
WING FITTING 2-WAY	15
WING FITTING 3-WAY	15
WING FITTINGS	15
WINGED DRILLPOINT SCREW	121
WIRE & CHAIN	29
WIRE BRUSH	168
WIRE ROPE	29/96
WIRE ROPE & ACCESSORIES	29
WIRE ROPE 45° BRACING BRACKET	29
WIRE ROPE ADAPTOR EYE BOLTS	29
WIRE ROPE DUCT CORNER	29
WIRE ROPE FEMALE EYE BOLTS	29
WIRE ROPE GRIP	29/96
WIRE ROPE MALE EYE BOLTS	29
WIRE ROPE STAINLESS STEEL EYE BOLTS	29
WIRE ROPE TURNBUCKLE	29
WIRE WHEELS	163
WOOD 6 TPI RECIPRO BLADE	164
WOOD-KNOCKER	103
YOKE ADJUSTABLE	33
YOKE ADJUSTABLE MEDIUM DUTY	33
Z	
Z BRACKET	84
ZINC STRUT CLIPS	39
ZIP-CLIP	27
ZIP-CLIP 2MM CON-LOCK END	27
ZIP-CLIP 2MM LOOP END	27
ZIP-CLIP 2MM PURLIN CLIP END	27
ZIP-CLIP 2MM SHOT FIRE END	28
ZIP-CLIP 3MM CON-LOCK END	28
ZIP-CLIP 3MM LOOP END	28
ZIP-CLIP 3MM PURLIN CLIP END	28
ZIP-CLIP CUTTER	142
ZIP-CLIP LOCK	29/96
ZIP-CLIP STRUT LOCK TRAPEZE DOME	29
ZIP-CLIP TENSIONER	142
ZIP-CLIP TOOLS	142



Screw/Bolt Size Identification

The description of the size of the screw is usually listed as three figures:

1. The first figure indicates the gauge of the screw (g).
2. The second figure indicates the threads per inch (T.P.I.).
3. The third figure in dictates the length of the screw - mm or inches (").

Gauge	4g	5g	6g	7g	8g	9g	10g	12g	14g
Diameter (mm)	2.85	3.3	3.5	3.9	4.2	4.5	4.8	5.5	6.3
Diameter (inches approx.)	7/64	1/8	9/64	5/32	11/64	0.177	3/16	7/32	1/4

Screw/Bolt Gauge

The gauge of the screw is determined by the basic size of the thread outside diameter.

Figure 1

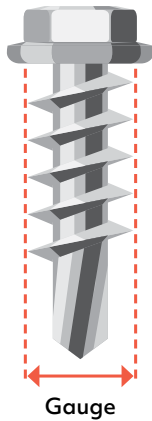

Screw/Bolt T.P.I.

The T.P.I. (thread per inch) is the number of thread crests that can be counted along a lineal measurement of 1" (25.4mm).

Figure 2

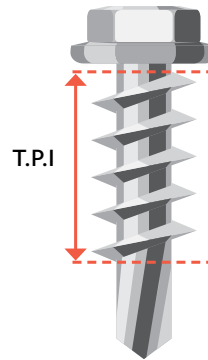

Screw/Bolt Length

Length is measured from the flat part of the head to the tip or blunt end of the screw/bolt. Some types of fasteners such as HEX bolts that are flat on top and bottom, are measured from the bottom or underside of the head as illustrated below.

Figure 3

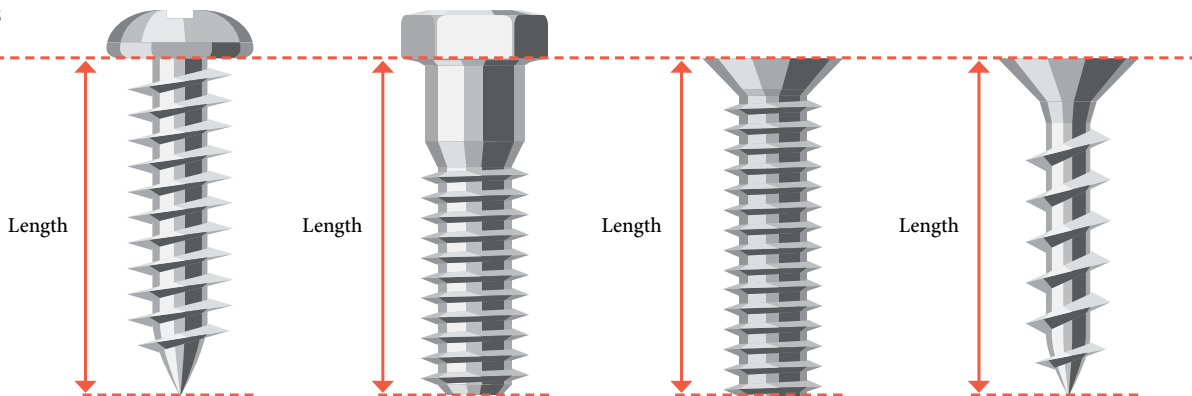

Chemical Usage Chart

Stud Size	M8	M10	M12	M16	M20
Hole Diameter (mm)	10	12	14	18	24
Hole Depth (mm)	80	90	110	125	145
N' of Holes per 380ml Cartridge	80	60	40	25	10

HVAC Strut Clip Size Chart

Refrigeration copper and lagging strut clip size when using pipe sleeves.

Copper Size	1/4	3/8	1/2	5/8	3/4	7/8	1 1/8
Copper Size (mm)	6.35	9.50	12.70	15.88	19.00	22.20	28.60
Clip for 19mm Wall (SKU)	19SCZ043	19SCZ048	19SCZ051	19SCZ054	19SCZ056	19SCZ060	19SCZ064
Clip for 25mm Wall (SKU)	19SCZ054	19SCZ060	19SCZ064	19SCZ064	19SCZ070	19SCZ073	19SCZ076



Copper Pipe

Nominal Size	15	18	20	25	32	40	50	65	80	90	100	125	150	175	200
O.D. mm	12.7	15.9	19.0	25.4	31.8	38.1	51.2	63.5	76.2	88.9	101.6	127.0	152.4	177.8	203.2
Mass Pipe kg/m	0.30	0.43	0.52	0.83	1.05	1.27	1.70	2.14	3.42	4.00	4.58	5.74	8.58	10.03	11.48
Mass pipe filled w/ water kg/m	0.39	0.58	0.75	1.25	1.72	2.27	3.57	5.07	7.60	9.76	12.18	17.77	25.86	33.74	42.63

HDPE Pipe

Nominal Size	25	32	40	50	65	80	100	125	150	200	250	300	350	400
O.D. mm	32	40	50	56	63	75	110	125	160	200	250	315	356	400
Mass Pipe kg/m		0.259	0.331	0.420				1.750		3.580	5.630			
Mass pipe filled w/ water kg/m		0.790	1.239	1.940				12.171		31.216	48.774			

DWV PVC Pipe

Nominal Size	32	40	50	65	80	100	150	225	300	375
O.D. mm	38.0	43.1	56.0	69.1	82.7	110.4	160.5	250.7	315.9	400.0
Mass Pipe kg/m	0.34	0.50	0.67	1.00	1.17	2.00	3.84	9.00	14.50	23.34
Mass pipe filled w/ water kg/m	1.14	1.76	2.59	4.14	5.58	9.85	21.51	48.74	85.15	133.73

Pressure PVC Pipe

Nominal Size	15	20	25	32	40	50	65	80	80	100	125	150	155	200	225	250	300	375
O.D. mm	21	27	34	42	48	60	75	89	89	114	140	160	168	225	250	280	315	400
Mass Pipe kg/m	0.15	0.25	0.39	0.62	0.80	1.26	2.13	2.31	2.31	4.50	7.43	9.67	10.00	15.83	15.66	24.83	31.60	51.65
Mass pipe filled w/ water kg/m	0.33	0.56	0.88	1.42	2.06	3.22	5.65	7.33	7.33	12.35	19.70	27.33	28.85	47.23	39.40	73.89	102.25	162.05

CPVC Pipe

Nominal Size	25	32	40	50
O.D. mm	34	43	48	60
Mass Pipe kg/m	0.39	0.62	0.82	1.28
Mass pipe filled w/ water kg/m	1.01	1.61	2.11	3.31

Steel Pipe

Nominal Size	8	10	15	20	25	32	40	50	65	80	90	100	125	150	200	250	300	350	400	450	500	600
O.D. mm	14	17	21	27	34	43	48	60	76	89	114	140	165	219	273	324	355	406	457	508	610	
Mass Pipe kg/m	0.68	0.89	1.27	1.65	2.52	3.24	3.73	5.24	6.69	8.68	12.40	16.50	19.60	42.53	60.29	73.82	81.28	93.21	105.14	117.07	140.94	
Mass pipe filled w/ water kg/m	0.74	1.01	1.47	2.02	3.11	4.26	5.11	7.46	10.42	13.82	21.11	29.75	38.55	74.81	111.14	146.81	170.05	211.05	255.75	304.85	414.85	

Steel Pipe Schedule 40

Nominal Size	8	10	15	20	25	32	40	50	65	80	90	100	125	150	200	250	300	350	400	450	500	600
O.D. mm	14	17	21	27	34	43	48	60	76	89	101	114	140	168	219	273	324	355	406	457	508	610
Mass Pipe kg/m	0.62	0.85	1.27	1.68	2.50	3.38	4.05	5.44	8.62	11.29	13.57	16.07	21.78	28.26	42.53	60.29	73.82	81.28	93.21	105.14	117.07	140.94
Mass pipe filled w/ water kg/m	0.69	0.97	1.47	2.11	3.06	4.35	5.37	7.60	11.71	16.06	19.95	24.28	34.69	46.91	74.81	111.14	146.81	170.05	211.05	255.75	304.85	414.85

Stainless Steel Tube

Nominal Size	15	18	22	28	35	42	54	76	89	108
O.D. mm	15	18	22	28	35	42	54	76	89	108
Wall Thickness	1.2	1.2	1.5	1.5	1.5	1.5	1.5	2.0	2.0	2.0
Mass Pipe kg/m	0.4135	0.5034	0.7678	0.9926	1.2547	1.5169	1.9664	3.7006	4.3398	5.2936
Mass pipe filled w/ water kg/m	0.5035	0.6534	0.9978	1.4126	1.9247	2.5169	3.8364	7.8806	10.0998	12.8936

FRC Pipe

Nominal Size	225	300	375	450	535	600	675	675	750
Pipe O.D. mm	269	346	427	512	594	678	752	752	802
Cutter O.D. mm	257	336	415	504	584	664	733	733	783
Mass Pipe kg/m	22	35	51	67	86	111	133	133	157
Mass pipe filled w/ water kg/m	61.74	105.70	161.39	225.96	310.89	393.60	393.60	490.66	598.80



Pressure Conversions

	1 Pascal =	1 Kilopascal =	1 Bar =	1 PSI =	1 Meter Head =
Pa	1	1000	100000	6894.75728	9804.139432
kPa	0.001	1	100	6.89475728	9.804139432
Bar	0.00001	0.01	1	0.0689475728	0.09804139432
PSI	0.00014503773801	0.14503773801	14.503773801	1	1.4219702063
Meter Head	0.0001019977334	0.1019977334	10.19977334	0.7032496149	1

Pressure Conversion Rates (rounded)

	20	40	60	80	100	200	300	400	500	600	700	800	900	1000	1100	1200	1300	1400	1500	1600	1700	1800	1900	2000
kPa	2.0	4.1	6.1	8.2	10.2	20.4	30.6	40.8	51.0	61.2	71.4	81.6	91.8	102.0	112.2	122.4	132.6	142.8	153.0	163.2	173.4	183.5	193.7	203.9
Bar	0.2	0.4	0.6	0.8	1.0	2.0	3.0	4.0	5.0	6.0	7.0	8.0	9.0	10.0	11.0	12.0	13.0	14.0	15.0	16.0	17.0	18.0	19.0	20.0
PSI	2.9	5.8	8.7	11.6	14.5	29.0	43.5	58.0	72.5	87.0	101.5	116.0	130.5	145.0	159.5	174.0	188.5	203.1	217.6	232.1	246.6	261.1	275.6	290.1
Meter Head	2.0	4.1	6.1	8.2	10.2	20.4	30.6	40.8	51.0	61.2	71.4	81.6	91.8	102.0	112.2	122.4	132.6	142.8	153.0	163.2	173.4	183.5	193.7	203.9

Metric Conversions

	Imperial	Metric	Factor
Length	inches	centimetres	2.54
	feet	metres	0.3048
	yards	metres	0.9144
	miles	kilometres	1.609347
Area	square inches	square centimetres	6.4516
	square feet	square metres	0.09290304
	square yards	square metres	0.83612736
	square miles	square kilometres	2.58998811
Volume	acres	hectares	0.404685642
	cubic inches	cubic centimetres	16.387064
	cubic feet	cubic metres	0.028316847
Mass	cubic yards	cubic metres	0.764554858
	ounces	grams	28.34952313
	pounds	kilograms	0.4536
Force	ton	tonne	1.016046909
	newton	kilogram - force	0.101972

Imperial Fraction to Metric Conversions

	Imperial Inch Fraction	Imperial Inch Decimal	Metric Millimeters
Length	1"	1.0"	25.4
	1/2"	0.5"	12.7
	1/4"	0.25"	6.35
	1/8"	0.125"	3.175
	1/16"	0.0625"	1.5875
	3/4"	0.75"	19.05
	3/8"	0.38"	9.53
	3/16"	0.19"	4.76
	3/32"	0.09"	2.38
	5/8"	0.63"	15.88
	5/16"	0.31"	7.94
	5/32"	0.16"	3.97
	7/8"	0.88"	22.23
	7/16"	0.44"	11.11

Flow Conversions

Litres per second	0.07577	0.00126	1	0.01667	0.27778	0.00787	0.06309
Litres per minute	4.546	0.07577	601	1	16.667	0.47195	3.785
Cubic Meter per hour	0.27277	0.00455	3.6	0.06	1	0.02832	0.22712
Cubic Feet per hour	9.633	0.16054	127.133	2.119	35.315	1	8.021

Power Conversions

Watt	1	0.001	0.293071	3516.853	745.6998716
Kilowatt	1000	1	0.000293071	3.516853	0.745699872
BTU per hour	3.41214245	3412.14245	1	12000.00341	2544.434187
Ton of Refrigeration	0.000284345	0.284345123	8.33333E-05	1	0.212036122
Horsepower	0.001341022	1.34102209	0.000393015	4.716177559	1

Temperature Conversions

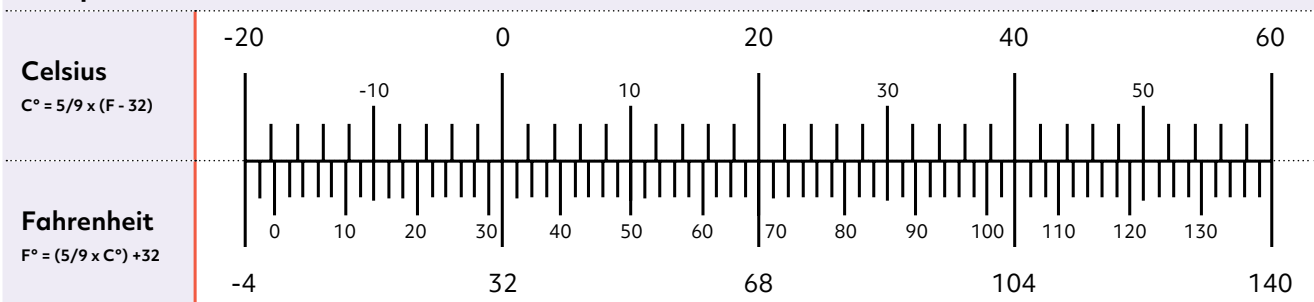



ACURA



WITH YOU ON SITE

1300 750 750

sales@acuragroup.com.au

www.acuragroup.com.au

South Australia
10 Selgar Avenue,
Tonsley, S.A. 5042

Western Australia
19 Wicks Street,
Bayswater, W.A. 6053